

bott avero

The workstation system

bott



Solutions for customer
service and production

	Page	
T	bott – an introduction	4 – 5
	Quality principles	6 – 7
	Your idea - our planning	8 – 9
Z	bott on the assembly line	10 – 15
	Ergonomics	16 – 17
E	bottBox, the materials box	18 – 19
	perfo, the original	20 – 21
T	ESD protection zones	22 – 23
	bott and Elabo	24 – 27
Z	Colour spectrum - Information for your product selection	28 – 29
	Single workstations	32 – 35
	Base frames	36 – 43
O	Worktops	43 – 47
	Accessories for table set-up	48 – 67
U	bottBoxes and Euroboxes	67 – 72
	swivelarms	73 – 77
	Accessories for system frame and swivel frame	78 – 82
	Accessories for table base	83 – 91
	Accessories	92 – 102
	FIFO shelf	103 – 104
	System packing table	104 – 107
Mobile systems	108 – 115	



bott – an introduction

For almost 90 years we have been offering our customers all over the world a wide-ranging product portfolio, the highest-possible quality and a first-class service. In particular, the high level of customer satisfaction ensures bott's continued growth.

Innovation has the highest priority at bott. With us you'll invest in a modern, long-term solution and therefore in lasting success.



Founded:	1930
No. of employees:	1300
Locations:	3
Countries:	> 35
Partners and branches:	> 100
Turnover:	196 million euros

Status: 2022



Experience makes the difference

As a long-term global partner, we supply consistently high-quality products, services and solutions that offer an excellent price-performance ratio. The result is an exceptional customer experience. We deliver intelligent workplace and mobility solutions for tradespeople and companies who are targeting greater operational efficiency or simply a better use of space.

To this end, we combine our innovative, high-value products and services with new technologies to create integrated, market-leading solutions that are based on thorough knowledge of customer needs. In a

fast-changing world, we must be agile and flexible. In a dynamic environment, we are constantly learning, working together on an international level and coming up with new products. This enables our employees and other stakeholders to contribute to our joint success and to benefit from it themselves.

Quality principles

Certified in
accordance with
DIN EN ISO 9001

Certified environmental management
in accordance with ISO 14001

Certified





Certified quality

High stability, sturdiness and durability:

These are our main principles for production of bott products. By delivering the best quality possible, we guarantee that your investment will be worthwhile. We always validate our production and logistics processes through internal and external guidelines, inspections and audits.

Our quality principles

- Certified in accordance with DIN EN ISO 9001
- Certified environmental management in accordance with ISO 14001

Your idea - our planning

Configuration depending on requirements

Practice oriented planning

Versatility and flexibility



Individual and variable

Are you looking for an innovative solution for manual assembly with simultaneous picking? We can adapt the avero workstation storage system exactly to your individual requirements. It thus provides you with ideal conditions to ensure efficiency, ergonomics and safety at your workstations.

For your industrial company to be successful in the long term under modern, global economic conditions, it needs to remain adaptable. It is only then that you can react quickly enough to new demands on a product. The avero workstation storage system's modular construction is versatile and flexible. Individual components can be readily and permanently adapted and expanded.

bott on the assembly line

Integrative modular system

Numerous combination
options

Connection to
existing systems



Flexibility in manual assembly

Thanks to the integrative modular system, you can create single and multi-workstations, assembly or handling lines and parts trolleys from only a few different components. Thanks to the special avero connection technology, you can combine steel serial parts with modules made of aluminium profiles. You can accommodate equipment of all kinds on the perforated walls and ergonomically adjustable material shelves at the required station in a clear and handy way.

Together with partner companies we offer you customised solutions for manual assembly, including connection to existing manufacturing systems and IT infrastructure.

Modularity

Versatility

Fast adaptation

Process reliability



Change requires adaptation

Modern manual production is only future-proof if you can adapt it to the continually changing individual requirements. With the modular avero workstation storage system, you can react to new challenges quickly and with reliable processes.

The modular avero system makes it easier to exchange and add elements. This way you are well prepared to handle a high number of variants precisely and without errors. A quick conversion to match new circumstances is easy to implement with avero.

Material flow

Material supplies

Time-saving transfer

Individual transport lines



Smooth transitions

To prevent you losing time for the transfer of material and workpieces, our avero system offers you numerous options for supplying and connecting workstations. Examples include supply trolleys, stationary or mobile material supply shelves, roller tracks, handling lines or even the integration of a driverless transport system.

In addition, you can connect the avero workstation storage systems via handling lines. The work piece carrier moves from station to station via wheels, rollers or balls. This way, our avero system guarantees your efficient material flow.

Thanks to an optimised material flow, production times can be reduced and processes made leaner. FIFO shelves ensure continuous supplies and guarantee smooth workflows.

Ergonomics

Maintaining health

Optimum posture

Correct lighting



Ergonomics

Your employees' health is an important resource. To help you keep them working healthily as long as possible, avero supports a favourable posture at the workstation. Infinitely variable shelves, swivel frames and height-adjustable tables make it easy to adapt working conditions to employee height.

The modern LED lighting at the workstation goes easy on the eyes and helps your employees concentrate better. The electric cables are housed securely and tidily in cable ducts. You can exit cables in the right place at brush strips. In addition, we are happy to integrate connector strips for you for the proper and secure connection of your IT equipment.

The bottBox

Provision of small parts

Systematic labelling

Ergonomic handling



The bottBox



reddot award 2015
winner industrial design

With the bottBox we are offering you a unique innovation. The bottBox stores small parts tidily and allows practical access to them. We have developed this product for use in industry, in the workshop and in service vehicles as well. The made in Germany bottBox received the iF Design Award and the Red Dot Award for its successful design and versatile properties.

The bottBox can be suspended on perforated panels or specially designated support rails. Dividers and transparent hinged lids turn it into the ideal material box for multiple purposes.

Ergonomically shaped handles ensure you always have the bottBox firmly in your hands. You can remove the viewing window and move it towards the back. The pane thus dispenses the small parts to be removed: the bottBox as a service tray.

You can replace the coloured clip for labelling the front of the bottBox. This makes systematic arrangement on the shelf easier for you and ensures clarity. You can also label the bottBox on the back using stock and Kanban cards if you wish: the bottBox as a shelf box.

perfo

Positioning tools

Careful sorting

Solid tool carriers



Organisation systems

You can provide tools clearly using the perfo perforated panel system. Everything is stored tidily and is quickly on hand. We supply a comprehensive range with perfo hooks, shelves and tool carriers.

perfo from bott guarantees efficiency and order at the workstation. The systematic provision of tools and small parts guarantees fast access to these. perfo offers a standardised system with numerous different perfo hooks and tool carriers. There's something for everyone here.

The powder-coated surfaces of the perfo perforated panels provide sturdy and long-term protection even under heavy loads. The perfo hooks are zinc-plated and extremely sturdy.

The concealed cable holders on the avero workstation storage system bundle and fix the electric cables in place. This way they ensure order, safety and flexibility. Thanks to the brush strips, the cables can exit the channel at any point.

ESD protection zones

Comprehensive protection during assembly

Conductive surfaces throughout

Equipment including removal



ESD protection zones

On request, we offer the avero workstation storage system in a complete ESD version. For the processing of microelectronic components, workstations with completely conductive surfaces are essential in many areas of manual assembly these days. They provide protection against uncontrolled electrostatic discharge and thus against invisible damage inside the components.

Electrostatically protected areas and ESD workstations are necessary almost throughout electronics manufacturing and semiconductor processing. We deliver the complete solution for your entire material flow chain from a single source: from

advice and definition of individual requirements through delivery of adequate ESD equipment and preparation of acceptance and test protocols as well as audit reports. We manufacture our ESD products in accordance with the IEC 61340-5-1 standard and have them tested accordingly.

Our ESD equipment is much more than just the ESD workstation: from storage cupboards for incoming goods areas through heavy duty trolleys or handling lines between workstations to parts trolleys or material supply shelves. This way, we can guarantee you ESD protection all the way.

Individual complete solution

Quality Assurance

Flexibility and variability



Future-proof manual assembly

avero in conjunction with assistance systems is the perfect complete solution. It creates the perfect conditions for consistently high product quality with maximum flexibility and variability.

bott and ELABO work with you to analyse your individual needs, and deliver the complete solution to suit your work processes and requirements.

The software solution in connection with the workstation storage system saves you time and consistently eliminates all sources of error. bott and ELABO optimise your development, productions, intralogistics and quality assurance processes. The systems can be adapted to changing requirements at any time. Leaving you perfectly equipped for the future.

Assistance and testing systems

Guided assembly

Management of
material supply

Inspection workflows and
testing processes



Integration of assembly instructions and test systems

The elution two software supports your workflows in modern assembly, increases your production quality and thus optimises your production productivity. elution two manages the material supply and supports employees in performing their tasks through the assistance system elution two assembly. Screens at the avero workstation visualise assembly instructions – individually adapted to the required degree of assistance. Pick-by-light systems reduce picking times and additionally help in selecting the right parts.

With modern technologies you ensure efficient work processes and maximise workflow productivity. Production processes can be coupled with directly subsequent testing processes on our modern assembly lines. Quality assurance steps integrated in-line supplement the assembly process. Faults are thus identified ahead of the end-of-the-line test. These efficient measures for fault testing provide particularly good support when there is a large number of variants.

Assistance and testing systems

High-variant products
produced efficiently

Shorter familiarisation time

Avoidance of errors



Digitally assisted workstations

With the digital assistance system elution two assembly you support both experienced assembly professionals and untrained employees with individual task schedules. They can thus assemble even high-variant and complex products with top production quality. Free your specialist personnel from time-consuming documentation so that they can concentrate on their core competence. The standardised interfaces from elution two assembly make simple integration in your existing IT environment possible. This means that the platform-independent solution not only connects individual workstations, it

also communicates with your higher-order systems. The task schedules in elution two assembly are designed for intuitive operation. On the one hand, this benefits your assembly employees, who receive optimum support thanks to instructions adapted to their skills and language. On the other, it is easy to create new task schedules and edit existing ones: authorised users can effortlessly make changes via drag & drop and thus react quickly to new workflows, products and variants.

Colour spectrum

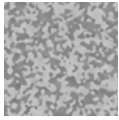

Environmentally friendly, permanent finely textured powder coating of steel parts

avero workstation storage systems are available in a modern colour combination of light grey and anthracite grey. The neutral design will match any production environment.

Special colors available on request!



ESD versions of workstation storage systems available

avero workstation storage systems are also available as an optional ESD version with conductive surfaces. Your bott representative will be more than happy to discuss ESD protection zones and ESD workstations with you.



Delivered pre-assembled

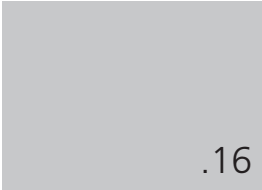
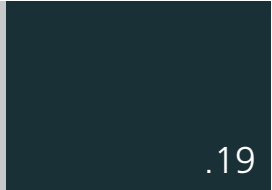

Colour combination:

	
.16	.19
Light grey RAL colour: 7035	Anthracite grey RAL colour: 7016

Colour combination: ESD:

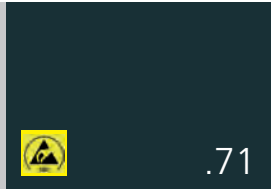
	
.20	.71
ESD light grey RAL colour: 7035	ESD anthracite grey RAL colour: 7016

The colour panels shown may not match the original colours for printing-related reasons.

Information for your product selection

Table frame with height adjuster via electric motor



- Mechanical, infinitely variable height adjuster with electric motor
- Memory function for 3 work heights
- Frame height (without worktop) 613 to 913 mm or 713 to 1113 mm
- Load capacity:
- Base frame without optional table set-up: 200 kg
- Base frame with optional table set-up: 300 kg

Table frame with height adjuster via hand crank



- Hydraulic, infinitely variable height adjuster with hand crank
- Frame height (without worktop) 613 to 913 mm or 713 to 1113 mm for table depth 750 and 900 mm
613 to 913 mm or 713 to 1013 mm for table depth 600 mm
- Load capacity:
- Base frame without optional table set-up: 200 kg
- Base frame with optional table set-up: 300 kg

Table frame with height adjustment in increments



- Height of table can be adjusted using hole spacing when legs are mounted
- Frame height (without worktop) 613 to 913 mm or 713 to 1113 mm
- adjustable in increments of 25 mm
- Load capacity:
- Base frame without optional table set-up: 200 kg
- Base frame with optional table set-up: 300 kg

avero system widths

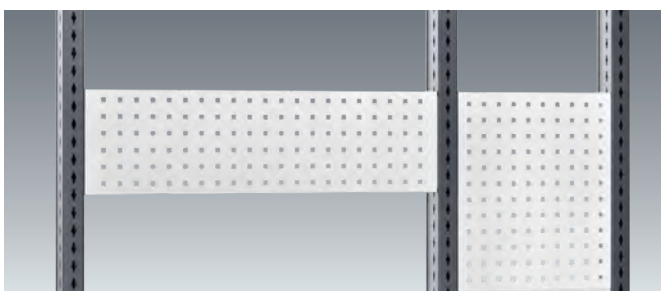

- avero system dimensions make the modular combination of components and assemblies possible
- System widths of table set-ups and accessories: 450, 900, 1350, 1800 mm
- Additional system width 675 mm with system and swivel frames as well as with supply and parts trolleys

Single workstations

Complete module 1 DE



- 3x vertical profile
- 3x cable duct with brush strips for vertical profile
- 2x overhead arm for vertical profile
- Suspended drawer cabinet W 375 x D 500 x H 300 mm with 2x 100 mm drawers and lock
- Overhead rail with carriage
- LED ECO 28 W strip light with 5 m connecting cable and Schuko plug
- Retaining rail with 3 gang Shuko socket strip, ON/OFF switch and 3 m connection cable with Schuko plug
- 2x perfo perforated panel, height 480 mm high, for system width 450 mm
- perfo perforated panel, 240 mm high, for system width 450 mm
- Tray, 350 mm deep, for system width 450 mm, kitted with 3 bottBoxes M3
- 2x tray, 200 mm deep, for system width 450 mm, kitted with 3 bottBoxes M2
- Swivel frame, system width 750 mm
- perfo perforated panel for swivel frame
- Tray, 350 mm deep, for swivel frame 450 mm, kitted with 4 bottBoxes M3
- Bin rail for swivel frame, kitted with 5 bottBoxes M3
- Laminate-coated worktop
- Table load 200 kg

The workstation system

Version	Height adjustment in increments	Height adjuster with hand crank	Height adjuster with electric motor
Dimensions W x D [mm]	1350 x 870	1350 x 870	1350 x 870
total height from - to [mm]	2.035-2.435	2.035-2.435	2.035-2.435
Work height table top from - to [mm]	743-1.143	743-1.143	743-1.143
Dimensions Worktop W x D x H [mm]	1.500 x 750 x 30	1.500 x 750 x 30	1.500 x 750 x 30
Order ref.	41032014.16	41032008.16	41032004.16

Single workstations

Complete module 2 DE



- 2x vertical profile
- 2x cable duct with brush strips for vertical profile
- 2x overhead arm for vertical profile
- Suspended drawer cabinet W 375 x D 500 x H 500 mm with 2x 200 mm drawers and lock
- Overhead rail with carriage
- LED ECO 42 W strip light with 5 m connecting cable and Schuko plug
- Retaining rail with 3 gang Shuko socket strip, ON/OFF switch and 3 m connection cable with Schuko plug
- perfo perforated panel for system width 1350 mm, system height 240 mm
- Tray, 200 mm deep, kitted with 10 bottBoxes M2
- Tray, 350 mm deep, kitted with 10 bottBoxes M3
- Swivel arm with system frame
- perfo perforated panel for system frames
- Tray, 200 mm deep, for system frame 450 mm, kitted with 4 bottBoxes M2
- Laminate-coated worktop
- Table load 200 kg

Version	Height adjustment in increments	Height adjuster with hand crank	Height adjuster with electric motor
Dimensions W x D [mm]	1350 x 870	1350 x 870	1350 x 870
total height from - to [mm]	2.035-2.435	2.035-2.435	2.035-2.435
Work height table top from - to [mm]	743-1.143	743-1.143	743-1.143
Dimensions Worktop W x D x H [mm]	1.500 x 750 x 30	1.500 x 750 x 30	1.500 x 750 x 30
Order ref.	41032011.16	41032005.16	41032001.16

Single workstations

Complete module 3 DE



- 2x vertical profile
- 2x cable duct with brush strips for vertical profile
- 2x overhead arm for vertical profile
- Suspended drawer cabinet B 225 x T 500 x H 500 mm with a 400 mm drawer and lock
- Overhead rail with carriage
- LED ECO 28 W strip light with 5 m connecting cable and Schuko plug
- Retaining rail with 3 gang Shuko socket strip, ON/OFF switch and 3 m connection cable with Schuko plug
- perfo perforated panel for system width 900 mm, system height 240 mm
- Tray, 200 mm deep, kitted with 6 bottBoxes M2
- Tray, 350 mm deep, kitted with 6 bottBoxes M3
- Retaining rail kitted with 6 bottBoxes M2
- Swivel frame, system width 675 mm
- perfo perforated panel for swivel frame
- Tray, 350 mm deep, for swivel frame 450 mm, kitted with 4 bottBoxes M3
- Bin rail for swivel frame, kitted with 5 bottBoxes M3
- Laminate-coated worktop
- Table load 200 kg

The workstation system

Version	Height adjustment in increments	Height adjuster with hand crank	Height adjuster with electric motor
Dimensions W x D [mm]	1350 x 870	1350 x 870	1350 x 870
total height from - to [mm]	2.035-2.435	2.035-2.435	2.035-2.435
Work height table top from - to [mm]	743-1.143	743-1.143	743-1.143
Dimensions Worktop W x D x H [mm]	1.500 x 750 x 30	1.500 x 750 x 30	1.500 x 750 x 30
Order ref.	41032013.16	41032007.16	41032003.16

Single workstations

Complete module 4 DE



- 3x vertical profile
- 3x cable duct with brush strips for vertical profile
- 2x overhead arm for vertical profile
- Suspended drawer cabinet B 225 x T 500 x H 500 mm with 2x 200 mm drawers and lock
- Overhead rail with carriage
- LED ECO 42 W strip light with 5 m connecting cable and Schuko plug
- Retaining rail with 3 gang Shuko socket strip, ON/OFF switch and 3 m connection cable with Schuko plug
- perfo perforated panel for system width 900 mm, system height 240 mm
- 2x tray, 200 mm deep, kitted with 6 bottBoxes M2
- 2x perfo perforated panel for system width 450 mm, system height 480 mm
- Laminate-coated worktop
- Table load 200 kg

Version	Height adjustment in increments	Height adjuster with hand crank	Height adjuster with electric motor
Dimensions W x D [mm]	1350 x 870	1350 x 870	1350 x 870
total height from - to [mm]	2.035-2.435	2.035-2.435	2.035-2.435
Work height table top from - to [mm]	743-1.143	743-1.143	743-1.143
Dimensions Worktop W x D x H [mm]	1.500 x 750 x 30	1.500 x 750 x 30	1.500 x 750 x 30
Order ref.	41032012.16	41032006.16	41032002.16

Base frames

Base frame with electric height adjustment without worktop



- Sturdy steel-aluminium frame
- Installation option on the back for vertical profiles in 225 mm pitch
- Base frames with infinitely variable height adjuster from 643 to 943 mm are particularly suitable for use with a castor set
- 4 height adjustable feet for evening out floor unevenness, height adjustable foot Ø 30 mm, adjustable range height adjustable foot 10 mm
- The bottom stringer also makes the attachment of a suspended footrest or computer holder possible
- Load capacity: 200 kg with load distributed evenly
- Colour: light grey (RAL 7035) powder-coated
- Base frame with system width 675 mm not suitable as a seated workplace
- UK version: Drive unit with Schuko plug and UK mains adapter

System width [mm]	675	675	675	675
Suitable for	DE	DE	DE	DE
Dimensions Worktop W x D [mm]	750 x 600	750 x 750	750 x 600	750 x 750
Height adjustment range with a worktop thickness of 30mm	643-943	643-943	743-1.143	743-1.143
Order ref.	41007111.16	41007113.16	41007112.16	41007114.16

System width [mm]	900	900	900	900
Suitable for	DE	DE	DE	DE
Dimensions Worktop W x D [mm]	1.000/1.200 x 600	1.000/1.200 x 750/900	1.000/1.200 x 600	1.000/1.200 x 750/900
Height adjustment range with a worktop thickness of 30mm	643-943	643-943	743-1.143	743-1.143
Order ref.	41007087.16	41007090.16	41007031.16	41007034.16

System width [mm]	1.350	1.350	1.350	1.350
Suitable for	DE	DE	DE	DE
Dimensions Worktop W x D [mm]	1.500 x 600	1.500 x 750/900	1.500 x 600	1.500 x 750/900
Height adjustment range with a worktop thickness of 30mm	643-943	643-943	743-1.143	743-1.143
Order ref.	41007088.16	41007091.16	41007032.16	41007035.16

System width [mm]	1.800	1.800	1.800	1.800
Suitable for	DE	DE	DE	DE
Dimensions Worktop W x D [mm]	2.000 x 600	2.000 x 750/900	2.000 x 600	2.000 x 750/900
Height adjustment range with a worktop thickness of 30mm	643-943	643-943	743-1.143	743-1.143
Order ref.	41007089.16	41007092.16	41007033.16	41007036.16

Base frames

Base frame with electric height adjustment without worktop ESD



- Sturdy steel-aluminium frame
- Installation option on the back for vertical profiles in 225 mm pitch
- Base frames with infinitely variable height adjuster from 643 to 943 mm are particularly suitable for use with a castor set
- 4 height adjustable feet for evening out floor unevenness, height adjustable foot Ø 30 mm, adjustable range height adjustable foot 10 mm
- The bottom stringer also makes the attachment of a suspended footrest or computer holder possible
- ESD version with conductive powder coating, conductive height adjustable feet, EBP with 3 snap fastener connections 10 mm and central earthing point
- Load capacity: 200 kg with load distributed evenly
- Colour: conductive powder-coated (RAL 7035)
- Base frame with system width 675 mm not suitable as a seated workplace
- UK version: Drive unit with Schuko plug and UK mains adapter

System width [mm]	675	675	675	675
Suitable for	DE	DE	DE	DE
Dimensions Worktop W x D [mm]	750 x 600	750 x 750	750 x 600	750 x 750
Height adjustment range with a worktop thickness of 30mm	643-943	643-943	743-1.143	743-1.143
Order ref.	41007111.20	41007113.20	41007112.20	41007114.20

System width [mm]	900	900	900	900
Suitable for	DE	DE	DE	DE
Dimensions Worktop W x D [mm]	1.000/1.200 x 600	1.000/1.200 x 750/900	1.000/1.200 x 600	1.000/1.200 x 750/900
Height adjustment range with a worktop thickness of 30mm	643-943	643-943	743-1.143	743-1.143
Order ref.	41007087.20	41007090.20	41007031.20	41007034.20

System width [mm]	1.350	1.350	1.350	1.350
Suitable for	DE	DE	DE	DE
Dimensions Worktop W x D [mm]	1.500 x 600	1.500 x 750/900	1.500 x 600	1.500 x 750/900
Height adjustment range with a worktop thickness of 30mm	643-943	643-943	743-1.143	743-1.143
Order ref.	41007088.20	41007091.20	41007032.20	41007035.20

System width [mm]	1.800	1.800	1.800	1.800
Suitable for	DE	DE	DE	DE
Dimensions Worktop W x D [mm]	2.000 x 600	2.000 x 750/900	2.000 x 600	2.000 x 750/900
Height adjustment range with a worktop thickness of 30mm	643-943	643-943	743-1.143	743-1.143
Order ref.	41007089.20	41007092.20	41007033.20	41007036.20

Base frames

Base frame with height adjuster via hand crank without worktop



- Sturdy steel-aluminium frame
- Installation option on the back for vertical profiles in 225 mm pitch
- Base frames with infinitely variable height adjuster from 643 to 943 mm are particularly suitable for use with a castor set
- 4 height adjustable feet for evening out floor unevenness, height adjustable foot Ø 30 mm, adjustable range height adjustable foot 10 mm
- Lowest stringer also makes the attachment of a hooked footrest or computer holder possible
- Load capacity: 200 kg with load distributed evenly
- Colour: light grey (RAL 7035) powder-coated

System width [mm]	675	675	675	675
Dimensions Worktop W x D [mm]	750 x 600	750 x 750	750 x 600	750 x 750
Height adjustment range with a worktop thickness of 30mm	643-943	643-943	743-1.043	743-1.143
Order ref.	41007119.16	41007121.16	41007120.16	41007122.16

System width [mm]	900	900	900	900
Dimensions Worktop W x D [mm]	1.000/1.200 x 600	1.000/1.200 x 750/900	1.000/1.200 x 600	1.000/1.200 x 750/900
Height adjustment range with a worktop thickness of 30mm	643-943	643-943	743-1.043	743-1.143
Order ref.	41007105.16	41007108.16	41007057.16	41007060.16

System width [mm]	1.350	1.350	1.350	1.350
Dimensions Worktop W x D [mm]	1.500 x 600	1.500 x 750/900	1.500 x 600	1.500 x 750/900
Height adjustment range with a worktop thickness of 30mm	643-943	643-943	743-1.043	743-1.143
Order ref.	41007106.16	41007109.16	41007058.16	41007061.16

System width [mm]	1.800	1.800	1.800	1.800
Dimensions Worktop W x D [mm]	2.000 x 600	2.000 x 750/900	2.000 x 600	2.000 x 750/900
Height adjustment range with a worktop thickness of 30mm	643-943	643-943	743-1.043	743-1.143
Order ref.	41007107.16	41007110.16	41007059.16	41007062.16

Base frames

Base frame with height adjuster via hand crank without worktop ESD



- Sturdy steel-aluminium frame
- Installation option on the back for vertical profiles in 225 mm pitch
- Base frames with infinitely variable height adjuster from 643 to 943 mm are particularly suitable for use with a castor set
- 4 height adjustable feet for evening out floor unevenness, height adjustable foot Ø 30 mm, adjustable range height adjustable foot 10 mm
- Lowest stringer also makes the attachment of a hooked footrest or computer holder possible
- ESD version with conductive powder coating, conductive height adjustable feet, EBP with 3 snap fastener connections 10 mm and central earthing point
- Load capacity: 200 kg with load distributed evenly
- Colour: conductive powder-coated (RAL 7035)

System width [mm]	675	675	675	675
Dimensions Worktop W x D [mm]	750 x 600	750 x 750	750 x 600	750 x 750
Height adjustment range with a worktop thickness of 30mm	643-943	643-943	743-1.043	743-1.143
Order ref.	41007119.20	41007121.20	41007120.20	41007122.20

System width [mm]	900	900	900	900
Dimensions Worktop W x D [mm]	1.000/1.200 x 600	1.000/1.200 x 750/900	1.000/1.200 x 600	1.000/1.200 x 750/900
Height adjustment range with a worktop thickness of 30mm	643-943	643-943	743-1.043	743-1.143
Order ref.	41007105.20	41007108.20	41007057.20	41007060.20

System width [mm]	1.350	1.350	1.350	1.350
Dimensions Worktop W x D [mm]	1.500 x 600	1.500 x 750/900	1.500 x 600	1.500 x 750/900
Height adjustment range with a worktop thickness of 30mm	643-943	643-943	743-1.043	743-1.143
Order ref.	41007106.20	41007109.20	41007058.20	41007061.20

System width [mm]	1.800	1.800	1.800	1.800
Dimensions Worktop W x D [mm]	2.000 x 600	2.000 x 750/900	2.000 x 600	2.000 x 750/900
Height adjustment range with a worktop thickness of 30mm	643-943	643-943	743-1.043	743-1.143
Order ref.	41007107.20	41007110.20	41007059.20	41007062.20

Base frames

Base frame with manual height adjustment without worktop



- Sturdy steel-aluminium frame
- Installation option on the back for vertical profiles in 225 mm pitch
- Manual height adjustment from 743 to 1143 mm, in 25 mm pitch, for use of a worktop 30 mm thick
- 4 height adjustable feet for evening out floor unevenness, height adjustable foot Ø 30 mm, adjustable range height adjustable foot 10 mm
- Lowest stringer also makes the attachment of a hooked footrest or computer holder possible
- Load capacity: 200 kg with load distributed evenly
- Colour: light grey (RAL 7035) powder-coated

System width [mm]	675	675	675	675
Dimensions Worktop W x D [mm]	750 x 600	750 x 750	750 x 600	750 x 750
Height adjustment range with a worktop thickness of 30mm	643-943	643-943	743-1.143	743-1.143
Order ref.	41007115.16	41007117.16	41007116.16	41007118.16

System width [mm]	900	900	900	900
Dimensions Worktop W x D [mm]	1.000/1.200 x 600	1.000/1.200 x 750/900	1.000/1.200 x 600	1.000/1.200 x 750/900
Height adjustment range with a worktop thickness of 30mm	643-943	643-943	743-1.143	743-1.143
Order ref.	41007099.16	41007102.16	41007037.16	41007040.16

System width [mm]	1.350	1.350	1.350	1.350
Dimensions Worktop W x D [mm]	1.500 x 600	1.500 x 750/900	1.500 x 600	1.500 x 750/900
Height adjustment range with a worktop thickness of 30mm	643-943	643-943	743-1.143	743-1.143
Order ref.	41007100.16	41007103.16	41007038.16	41007041.16

System width [mm]	1.800	1.800	1.800	1.800
Dimensions Worktop W x D [mm]	2.000 x 600	2.000 x 750/900	2.000 x 600	2.000 x 750/900
Height adjustment range with a worktop thickness of 30mm	643-943	643-943	743-1.143	743-1.143
Order ref.	41007101.16	41007104.16	41007039.16	41007042.16

Version	Pre-assembly base frame
Order ref.	30001041

Base frames

Base frame with manual height adjustment without worktop ESD



- Sturdy steel-aluminium frame
- Installation option on the back for vertical profiles in 225 mm pitch
- Manual height adjustment from 743 to 1143 mm, in 25 mm pitch, for use of a worktop 30 mm thick
- 4 height adjustable feet for evening out floor unevenness, height adjustable foot Ø 30 mm, adjustable range height adjustable foot 10 mm
- Lowest stringer also makes the attachment of a hooked footrest or computer holder possible
- ESD version with conductive powder coating, conductive height adjustable feet, EBP with 3 snap fastener connections 10 mm and central earthing point
- Load capacity: 200 kg with load distributed evenly
- Colour: conductive powder-coated (RAL 7035)

System width [mm]	675	675	675	675
Dimensions Worktop W x D [mm]	750 x 600	750 x 750	750 x 600	750 x 750
Height adjustment range with a worktop thickness of 30mm	643-943	643-943	743-1.143	743-1.143
Order ref.	41007115.20	41007117.20	41007116.20	41007118.20

System width [mm]	900	900	900	900
Dimensions Worktop W x D [mm]	1.000/1.200 x 600	1.000/1.200 x 750/900	1.000/1.200 x 600	1.000/1.200 x 750/900
Height adjustment range with a worktop thickness of 30mm	643-943	643-943	743-1.143	743-1.143
Order ref.	41007099.20	41007102.20	41007037.20	41007040.20

System width [mm]	1.350	1.350	1.350	1.350
Dimensions Worktop W x D [mm]	1.500 x 600	1.500 x 750/900	1.500 x 600	1.500 x 750/900
Height adjustment range with a worktop thickness of 30mm	643-943	643-943	743-1.143	743-1.143
Order ref.	41007100.20	41007103.20	41007038.20	41007041.20

System width [mm]	1.800	1.800	1.800	1.800
Dimensions Worktop W x D [mm]	2.000 x 600	2.000 x 750/900	2.000 x 600	2.000 x 750/900
Height adjustment range with a worktop thickness of 30mm	643-943	643-943	743-1.143	743-1.143
Order ref.	41007101.20	41007104.20	41007039.20	41007042.20

Version	Pre-assembly base frame
Order ref.	30001041

Base frames

Castor set for base frame



- Upgrade set to turn average base frames into a mobile single workstation
- 4 swivel castors diameter 100 mm with brake
- Stringer made of conductive powder-coated sheet steel for installation on the base profiles of the base frames
- Raises working area by 125 mm
- Load capacity 200 kg
- Colour: anthracite grey (RAL 7016)
- Info: Not suitable as heavy duty trolley!
- Can only be moved on even hall floor!

Suitable for base frame with system width [mm]	675	900	1,350	1,800
Dimensions Ø x H [mm]	100 x 125	100 x 125	100 x 125	100 x 125
Order ref.	41430131.19	41430079.19	41430080.19	41430081.19

Castor set for base frame ESD



- Upgrade set to turn average base frames into a mobile single workstation
- 4 swivel castors diameter 100 mm with brake
- Stringer made of conductive powder-coated sheet steel for installation on the base profiles of the base frames
- Raises working area by 125 mm
- Load capacity 200 kg
- Colour: anthracite grey (RAL 7016)
- ESD version with conductive swivel castors
- Info: Not suitable as heavy duty trolley!
- Can only be moved on even hall floor!

Suitable for base frame with system width [mm]	675	900	1,350	1,800
Dimensions Ø x H [mm]	100 x 125	100 x 125	100 x 125	100 x 125
Order ref.	41430131.71	41430079.71	41430080.71	41430081.71

Melamine-coated worktop

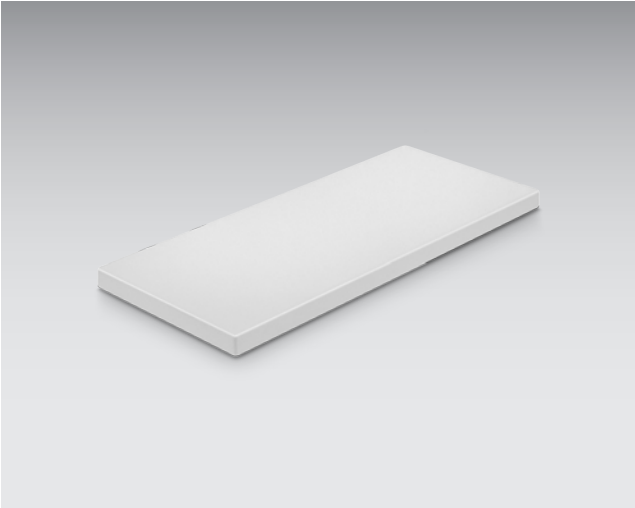

- Thickness: 30 mm
- Base material: chipboard in accordance with EN309/EN312
- Top side: melamine-coated in accordance with EN14322/EN14323
- Underside: melamine-coated in accordance with EN14322/EN14323
- Edges: 3 mm ABS edging anti-static, rounded radius R3
- Incl. Rampa fittings
- Coating characteristics: normal abrasion resistance, moderate scratch and impact resistance, insensitive to staining by Group 1 and 2 substances in accordance with DIN 53799 (e.g. acetone, alcohol, white spirit, nail polish remover, organic solvents)
- Fire protection class: D-s2, d0
- Colour: light grey

Dimensions W x D x H [mm]	750 x 600 x 30	750 x 750 x 30	1000 x 600 x 30	1000 x 750 x 30
Order ref.	41201142.01	41201143.01	41201082.01	41201083.01

Dimensions W x D x H [mm]	1200 x 600 x 30	1200 x 750 x 30	1200 x 900 x 30
Order ref.	41201084.01	41201085.01	41201086.01

Dimensions W x D x H [mm]	1500 x 600 x 30	1500 x 750 x 30	1500 x 900 x 30
Order ref.	41201087.01	41201088.01	41201089.01

Dimensions W x D x H [mm]	2000 x 600 x 30	2000 x 750 x 30	2000 x 900 x 30
Order ref.	41201090.01	41201091.01	41201092.01



Worktops

Melamine-coated worktop ESD

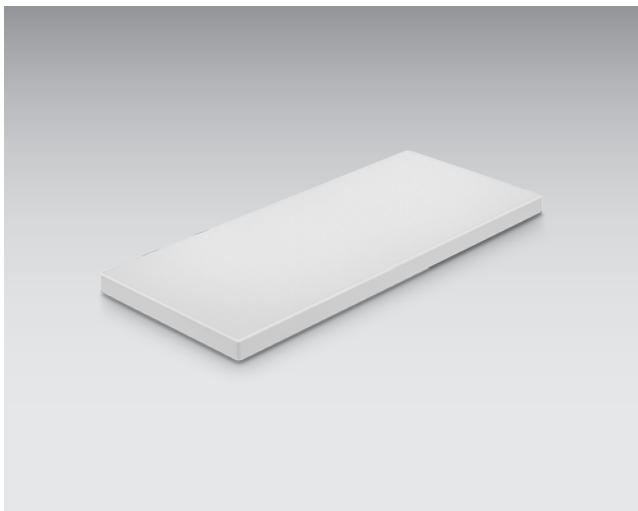

- Thickness: 30 mm
- Edges: 3 mm ABS edging anti-static, rounded radius R3
- Incl. Rampa fittings
- Coating characteristics: normal abrasion resistance, moderate scratch and impact resistance, insensitive to staining by Group 1 and 2 substances in accordance with DIN 53799 (e.g. acetone, alcohol, white spirit, nail polish remover, organic solvents)
- Fire protection class: D-s2, d0
- Colour: light grey
- Base material: volume conductive ESD chipboard in accordance with EN309/EN312
- Top side: conductive melamine-coated in accordance with EN14322/EN14323
- Underside: conductive melamine-coated in accordance with EN14322/EN14323
- Leakage values: in accordance with IEC61340

Dimensions W x D x H [mm]	750 x 600 x 30	750 x 750 x 30	1000 x 600 x 30	1000 x 750 x 30
Order ref.	41201142.04	41201143.04	41201082.04	41201083.04

Dimensions W x D x H [mm]	1200 x 600 x 30	1200 x 750 x 30	1200 x 900 x 30
Order ref.	41201084.04	41201085.04	41201086.04

Dimensions W x D x H [mm]	1500 x 600 x 30	1500 x 750 x 30	1500 x 900 x 30
Order ref.	41201087.04	41201088.04	41201089.04

Dimensions W x D x H [mm]	2000 x 600 x 30	2000 x 750 x 30	2000 x 900 x 30
Order ref.	41201090.04	41201091.04	41201092.04



Laminate coated worktop

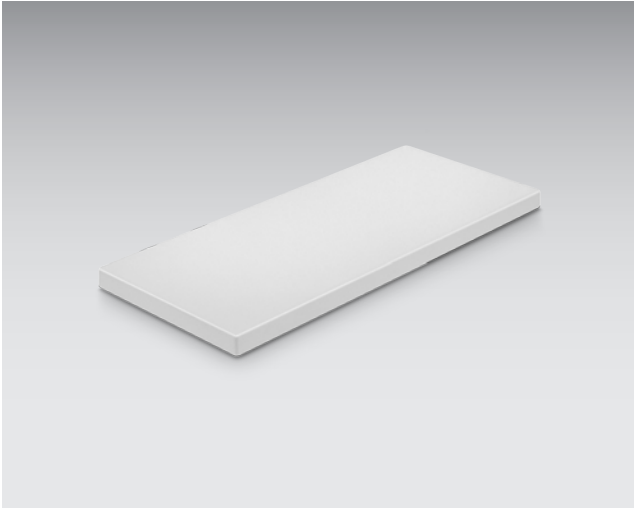

- Thickness: 30 mm
- Base material: chipboard in accordance with EN309/EN312
- Top side: HP laminate 0.8 mm in accordance with EN438
- Underside: HP laminate
- Edges: 3 mm ABS edging anti-static, rounded radius R3
- Incl. Rampa fittings
- Coating characteristics: high abrasion resistance, high impact resistance, high scratch resistance, insensitive to boiling water, resistant to common chemicals, solvents, weak acids and alkalis
- Fire protection class: D-s2, d0
- Colour: light grey

Dimensions W x D x H [mm]	750 x 600 x 30	750 x 750 x 30	1000 x 600 x 30	1000 x 750 x 30
Order ref.	41201142.02	41201143.02	41201082.02	41201083.02

Dimensions W x D x H [mm]	1200 x 600 x 30	1200 x 750 x 30	1200 x 900 x 30
Order ref.	41201084.02	41201085.02	41201086.02

Dimensions W x D x H [mm]	1500 x 600 x 30	1500 x 750 x 30	1500 x 900 x 30
Order ref.	41201087.02	41201088.02	41201089.02

Dimensions W x D x H [mm]	2000 x 600 x 30	2000 x 750 x 30	2000 x 900 x 30
Order ref.	41201090.02	41201091.02	41201092.02

Worktops

Laminate coated worktop ESD

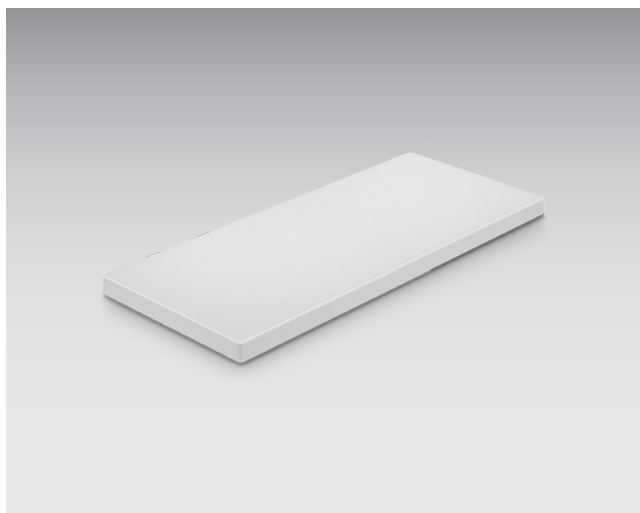

- Thickness: 30 mm
- Edges: 3 mm ABS edging anti-static, rounded radius R3
- Incl. Rampa fittings
- Coating characteristics: high abrasion resistance, high impact resistance, high scratch resistance, insensitive to boiling water, resistant to common chemicals, solvents, weak acids and alkalis
- Fire protection class: D-s2, d0
- Colour: light grey
- Base material: volume conductive ESD chipboard in accordance with EN309/EN312
- Top side: conductive HP laminate 0.8 mm in accordance with EN438
- Underside: HP laminate
- Leakage values: in accordance with IEC61340

Dimensions W x D x H [mm]	750 x 600 x 30	750 x 750 x 30	1000 x 600 x 30	1000 x 750 x 30
Order ref.	41201142.05	41201143.05	41201082.05	41201083.05

Dimensions W x D x H [mm]	1200 x 600 x 30	1200 x 750 x 30	1200 x 900 x 30
Order ref.	41201084.05	41201085.05	41201086.05

Dimensions W x D x H [mm]	1500 x 600 x 30	1500 x 750 x 30	1500 x 900 x 30
Order ref.	41201087.05	41201088.05	41201089.05

Dimensions W x D x H [mm]	2000 x 600 x 30	2000 x 750 x 30	2000 x 900 x 30
Order ref.	41201090.05	41201091.05	41201092.05

Beech multiplex worktop



- Thickness: 30 mm
- Quality: II / III in accordance with DIN 68705 Part 2
- Top side: oiled
- Underside: oiled
- Incl. Rampa fittings
- Colour: beech natural
- Bonding: laminated bi-directionally bonded beech veneers, bonding resistant in rooms with increased air humidity and occasional contact with water

Dimensions W x D x H [mm]	750 x 600 x 30	750 x 750 x 30	1000 x 600 x 30	1000 x 750 x 30
Order ref.	41201142.08	41201143.08	41201082.08	41201083.08

Dimensions W x D x H [mm]	1200 x 600 x 30	1200 x 750 x 30	1200 x 900 x 30
Order ref.	41201084.08	41201085.08	41201086.08

Dimensions W x D x H [mm]	1500 x 600 x 30	1500 x 750 x 30	1500 x 900 x 30
Order ref.	41201087.08	41201088.08	41201089.08

Dimensions W x D x H [mm]	2000 x 600 x 30	2000 x 750 x 30	2000 x 900 x 30
Order ref.	41201090.08	41201091.08	41201092.08

Accessories for table set-up

Vertical profile

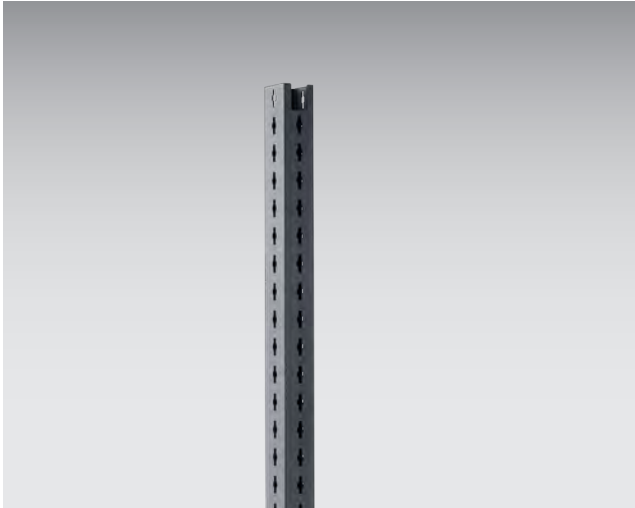

- Sturdy conductive powder-coated steel tube with avero perforation on all 4 sides
- For attaching avero accessories at a 40 mm height increment
- Installation on the back of the avero base frame at a 225 mm width increment
- Colour: anthracite grey (RAL 7016)

Dimensions W x D x H [mm]	50 x 60 x 557	50 x 60 x 1197	50 x 60 x 1836
Version	For attachments under the table top	For half-height set-ups	For set-ups with overhead arms
Order ref.	41012019.71	41012016.71	41012007.71

Cable duct for vertical profile



- Cable holder set for installation on the vertical profile
- Cables or hoses are bundled and fixed in place using cable holders
- Cable duct with vertical brush strips on both sides for concealed cable guiding
- Cable duct is inserted onto the cable holders
- Cable exit at any point thanks to brush strips
- Maximum cable/hose diameter 25 mm for cable exit at the brush strips
- Colour: black

Dimensions W x D x H [mm]	48 x 35 x 557	48 x 35 x 1037	48 x 35 x 1197	48 x 35 x 1357	48 x 35 x 1837	48 x 35 x 2157
Version	For attachments under the table top	For transport systems	For half-height set-ups	For mounting frames	For single workstations	For multi-workstations
Order ref.	43504005.10	43504001.10	43504006.10	43504004.10	43504002.10	43504003.10

Accessories for table set-up

Overhead arm



- Installed at the top of the vertical profile
- With avero perforation on the side surfaces
- Cut-out at the transition to the vertical profile for concealed cable guiding
- For attaching avero accessories at a 40 mm depth increment
- Made of conductive powder-coated sheet steel
- Colour: anthracite grey (RAL 7016)
- The bott logo is attached to the outer overhead arm during final assembly

Dimensions W x D x H [mm]	57 x 645 x 117
Order ref.	41011010.71

Overhead rail with carriage



- For fastening to the avero overhead arms
- Variable depth adjustment for installation at increments of 40 mm
- Incl. 1 carriage with snap hook
- Stopper element for carriage at both ends
- Carriage load capacity 10 kg
- Overhead rail load capacity 30 kg
- Overhead rail made of conductive powder-coated sheet steel
- Colour: light grey (RAL 7035)

For system width [mm]	675	900	1.350	1.800	Carriage with snap hook	Pair of stoppers
Depth [mm]	30	30	30	30	28	30
Height [mm]	100	100	100	100	98	25
Order ref.	41011179.16	41011026.16	41011027.16	41011028.16	80911002	80802005

Accessories for table set-up

Overhead rail with carriage ESD



- For fastening to the avero overhead arms
- Variable depth adjustment for installation at increments of 40 mm
- Incl. 1 carriage with snap hook
- Stopper element for carriage at both ends
- Carriage load capacity 10 kg
- Overhead rail load capacity 30 kg
- Overhead rail made of conductive powder-coated sheet steel
- Colour: light grey (RAL 7035)
- ESD version with carriage with metal wheels

For system width [mm]	675	900	1.350	1.800	Carriage with snap hook
Depth [mm]	30	30	30	30	22
Height [mm]	100	100	100	100	98
Order ref.	41011179.20	41011026.20	41011027.20	41011028.20	80911007

LED strip light / LED ECO strip light



- Particularly energy-efficient and long-lasting thanks to the use of LED lamps
- Low glare level thanks to prism cover in front of the lamp
- ON/OFF switch on the front of the housing
- GST-18 power supply socket on the back of the housing
- Light colour: daylight white 5500 Kelvin
- For fastening to the avero overhead arms
- Variable depth adjustment for installation at increments of 40 mm
- Type of protection IP40
- Protection class I
- Colour: anodised aluminium

system width [mm]	900	900	1.350	1.350	1.800	1.800
Version	eco	standard	eco	standard	eco	standard
Illumination level at a distance of 100 cm [lx]	745	1.437	1.003	1.958	1.201	2.331
Illumination level (maximum value)	1.002	1.925	1.283	2.513	1.490	2.891
Dimensions W x D x H [mm]	900 x 140 x 60	900 x 140 x 40	1350 x 140 x 60	1350 x 140 x 40	1800 x 140 x 60	1800 x 140 x 40
Lamp	LED 28 W	LED 52 W	LED 42 W	LED 77 W	LED 52 W	LED 100 W
Order ref.	50502092.97	50502067.97	50502093.97	50502068.97	50502094.97	50502069.97

Accessories for table set-up

Lateral LED strip light

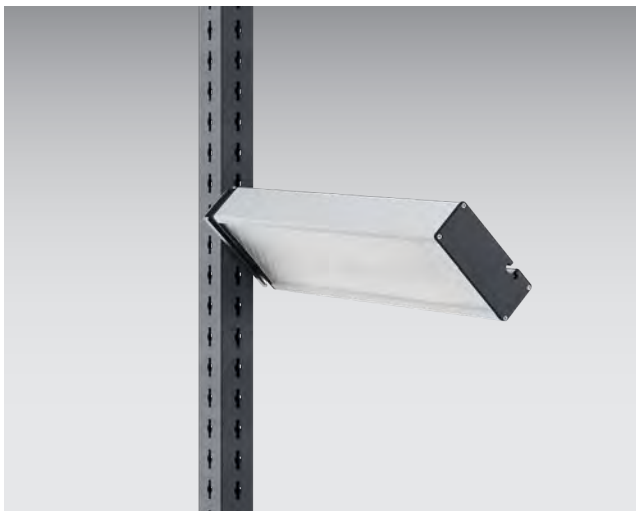

- Particularly energy-efficient and long-lasting thanks to the use of LED lamps
- Low glare level thanks to prism cover in front of the lamp
- ON/OFF switch on the front of the housing
- GST-18 power supply socket on the back of the housing
- Light colour: daylight white 5500 Kelvin
- For fastening to the avero vertical profile
- Variable height adjustment for installation at increments of 40 mm
- Inclination continually adjustable by +/- 30°
- Type of protection IP40
- Protection class I
- Colour: anodised aluminium

Illumination level at a distance of 100 cm [lx]	763
Illumination level (maximum value)	1.061
Dimensions W x D x H [mm]	472 x 140 x 40
Lamp	LED 28 W
Order ref.	50502070.97

Dimming module for 1x LED strip light



- Dimming module for retrofitting avero LED strip lights
- For connection of 1x LED strip light
- Ideal for single workstations
- Die-cast aluminium housing (black) with rotary potentiometer and 3m connection cable
- incl. fixing kits for mounting on avero vertical profiles and perforated panels

Description	Dimming module for 1x LED strip light
Order ref.	50203003

Accessories for table set-up

Dimming module for 6x LED strip light



- Dimming module for retrofitting avero LED strip lights
- For connection of up to 6x LED strip lights
- Ideal for multi-workstations and assembly lines
- Aluminium housing (anodised) with rotary potentiometer
- incl. fixing kits for mounting on avero vertical profiles and perforated panels

Description	Dimming module for 6x LED strip light	Connection cable for dimming module 1m	Connection cable for dimming module 2m	Connection cable for dimming module 3m	Connection cable for dimming module 4m	Connection cable for dimming module 5m
Order ref.	50203005	50203006	50203007	50203008	50203009	50203010

Socket strip

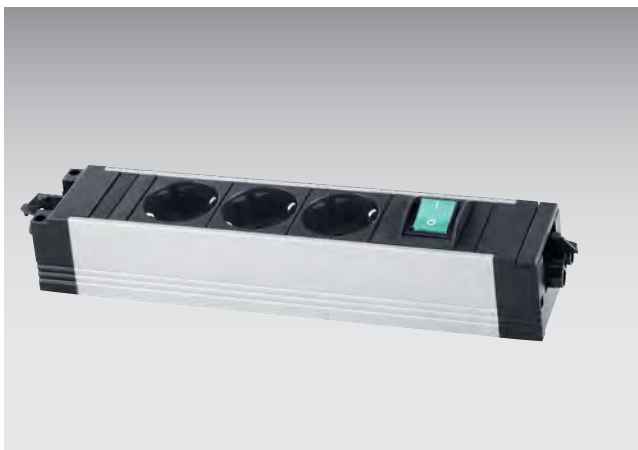

- For sliding into the support rails of the avero range
- With optional fixing kit to make installation on avero vertical profiles or perforated panels possible
- GST-18 connector for connection of a mains cable or connecting cable for further socket strips
- Socket strips can be fitted together directly via the GST-18 connector
- Colour: black / anodised aluminium

Version	3x Schuko power socket 16A	On/off switch, 3x Schuko power socket 16A	FI 30 mA, on/off switch, 2x Schuko power socket 16A	2x Schuko power socket 16A, 1x USB, 1x RJ45 (network)	5x Schuko power socket 16A (plastic housing)
Dimensions W x D x H [mm]	230 x 44 x 52	272 x 44 x 52	360 x 78 x 52	220 x 44 x 52	315 x 44 x 52
Suitable for	D/HU/B				D/HU
Order ref.	51001063	51001064	51001065	51001066	51001124

Version	3x power socket	On/off switch, 3x Schuko power socket	FI 30 mA, on/off switch, 3x power socket	2x power socket, 1x USB, 1x RJ45 (network)
Dimensions W x D x H [mm]	220 x 44 x 52	275 x 44 x 52	400 x 78 x 52	220 x 44 x 52
Suitable for	DK			
Order ref.	51001067	51001068	51001069	51001070

Accessories for table set-up

Version	3x power socket	On/off switch, 3x Schuko power socket	FI 30 mA, on/off switch, 3x power socket	2x power socket, 1x USB, 1x RJ45 (network)
Dimensions W x D x H [mm]	220 x 44 x 52	275 x 44 x 52	400 x 78 x 52	220 x 44 x 52
Suitable for	CH			
Order ref.	51001071	51001072	51001073	51001074

Version	3x power socket	On/off switch, 3x Schuko power socket	FI 30 mA, on/off switch, 2x power socket	2x power socket, 1x USB, 1x RJ45 (network)
Dimensions W x D x H [mm]	220 x 44 x 52	265 x 44 x 52	360 x 78 x 52	220 x 44 x 52
Suitable for	F			
Order ref.	51001097	51001098	51001099	51001100

Version	3x power socket	On/off switch, 3x Schuko power socket	FI 30 mA, on/off switch, 3x power socket	2x power socket, 1x USB, 1x RJ45 (network)
Dimensions W x D x H [mm]	285 x 44 x 52	325 x 44 x 52	455 x 78 x 52	255 x 44 x 52
Suitable for	UK			
Order ref.	51001101	51001102	51001103	51001104

Power cable for lamps and socket strips

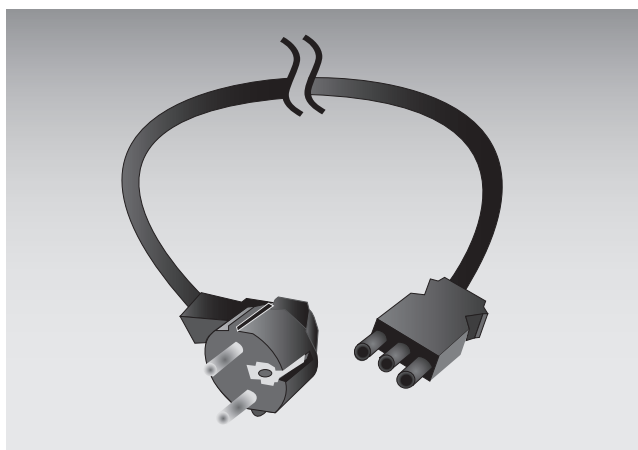

- Connection cable for power supply for the service ducts

Version	Schuko plug, GST18 socket, 230V / 16 A, 3-pin	Schuko plug, GST18 socket, 230V / 16 A, 3-pin	DK plug, GST-18 socket, 13 A	DK plug, GST-18 socket, 13 A
Length [m]	3	5	3	5
Suitable for	D/F/HU/B	D/F/HU/B	DK	DK
Order ref.	43503001	43503002	43503014	43503015

Version	CH plug Type 25, GST18 socket, 230V / 16 A, 3-pin	CH plug Type 25, GST18 socket, 230V / 16 A, 3-pin	UK plug, GST-18 socket, 13 A	UK plug, GST-18 socket, 13 A
Length [m]	3	5	3	5
Suitable for	CH	CH	UK	UK
Order ref.	43503012	43503013	43503003	43503004

Accessories for table set-up

GST 18 connecting cable

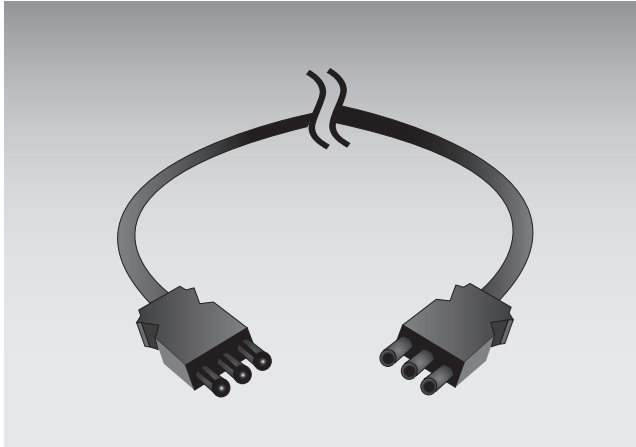

- Connection cable for power supply for the service ducts

Version	GST-18 plug, GST-18 socket, 16A	GST-18 plug - GST18-socket
Length [m]	1	3
Suitable for	Connecting cable	Connecting cable
Order ref.	43503007	43503021

Support rail for socket strips

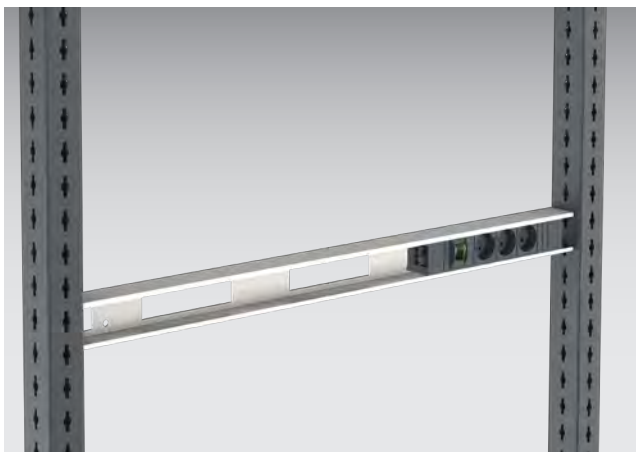

- For sliding into the socket strips of the avero range
- With punch-outs on the back for threading cables through
- For installation on the avero vertical profile
- Made of conductive powder-coated sheet steel
- Colour: light grey (RAL 7035)
- UK version with additional retainer plates

For system width [mm]	450	675	900	1.350	1.800
Version	D/F/DK/HU/CH				
Dimensions W x D x H [mm]	450 x 48 x 73	675 x 48 x 73	900 x 48 x 73	1350 x 48 x 73	1800 x 48 x 73
Order ref.	41011018.20	41011269.20	41011019.20	41011020.20	41011021.20

For system width [mm]	450	675	900	1.350	1.800
Version	UK				
Dimensions W x D x H [mm]	450 x 25 x 57	675 x 25 x 57	900 x 25 x 57	1350 x 25 x 57	1800 x 25 x 57
Order ref.	41011170.20	41011270.20	41011171.20	41011172.20	41011173.20

Accessories for table set-up

Cable tray



- For attaching socket strips and cables
- Cut-outs at the side for direct access to the cable duct in the vertical profiles
- For installation underneath the table top or between the avero vertical profiles
- Made of conductive powder-coated sheet steel
- Colour: light grey (RAL 7035)

For system width [mm]	450	675	900	1.350	1.800
Dimensions W x D x H [mm]	450 x 86 x 100	675 x 86 x 100	900 x 86 x 100	1350 x 86 x 100	1800 x 86 x 100
Order ref.	42105032.20	42105043.20	42105033.20	42105034.20	42105035.20

Shelf tray 200 and 350 mm depth with bottBoxes



- Equipped with service trays of the bottBox series
- Made of powder-coated sheet steel
- With hooks for suspending in the avero vertical profile
- Raised lip on one side, 20 mm high
- Shelf tray can optionally be installed with the raised lip on the front or the back
- Inclination infinitely variable, adjustable +/- 30°
- Infinitely variable depth adjustment
- Load capacity 60 kg
- Colour: light grey powder-coated conductive (RAL 7035), bottBoxes anthracite grey (RAL 7016)

For system width [mm]	450	675	900	1.350	1.800
Dimensions W x D x H [mm]	450 x 200 x 126	675 x 200 x 126	900 x 200 x 126	1350 x 200 x 126	1800 x 200 x 126
Depth adjustment range [mm]	67	67	67	67	67
Quantity bottBoxes	3x M2	4 x M2	6x M2	10x M2	13x M2
Order ref.	41011047.16	41011183.16	41011048.16	41011049.16	41011050.16

For system width [mm]	450	675	900	1.350	1.800
Dimensions W x D x H [mm]	450 x 350 x 200	675 x 350 x 200	900 x 350 x 200	1350 x 350 x 200	1800 x 350 x 200
Depth adjustment range [mm]	217	217	217	217	217
Quantity bottBoxes	3x M3	4 x M3	6x M3	10x M3	13x M3
Order ref.	41011051.16	41011184.16	41011052.16	41011053.16	41011054.16

Accessories for table set-up

Shelf tray 200 and 350 mm depth with bottBoxes ESD



- Equipped with service trays of the bottBox series
- Made of powder-coated sheet steel
- With hooks for suspending in the avero vertical profile
- Raised lip on one side, 20 mm high
- Shelf tray can optionally be installed with the raised lip on the front or the back
- Inclination infinitely variable, adjustable +/- 30°
- Infinitely variable depth adjustment
- Load capacity 60 kg
- Colour: light grey powder-coated conductive (RAL 7035), bottBoxes anthracite grey (RAL 7016)
- ESD version with conductive bottBoxes (black)

For system width [mm]	450	675	900	1.350	1.800
Dimensions W x D x H [mm]	450 x 200 x 126	675 x 200 x 126	900 x 200 x 126	1350 x 200 x 126	1800 x 200 x 126
Depth adjustment range [mm]	67	67	67	67	67
Quantity bottBoxes	3 x M2	4 x M2	6 x M2	10 x M2	13 x M2
Order ref.	41011047.20	41011183.20	41011048.20	41011049.20	41011050.20

For system width [mm]	450	675	900	1.350	1.800
Dimensions W x D x H [mm]	450 x 350 x 200	675 x 350 x 200	900 x 350 x 200	1350 x 350 x 200	1800 x 350 x 200
Depth adjustment range [mm]	217	217	217	217	217
Quantity bottBoxes	3 x M3	4 x M3	6 x M3	10 x M3	13 x M3
Order ref.	41011051.20	41011184.20	41011052.20	41011053.20	41011054.20

Accessories for table set-up

Shelf tray 200 and 350 mm depth

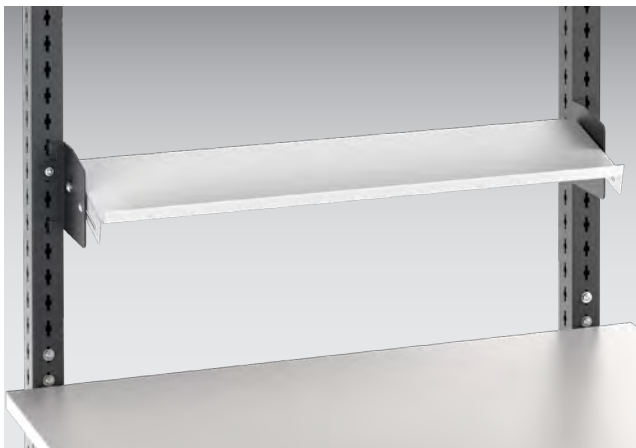

- With hooks for suspending in the avero vertical profile
- Raised lip on one side, 20 mm high
- Shelf tray can optionally be installed with the raised lip on the front or the back
- Inclination continually adjustable by +/- 30°
- Infinitely variable depth adjustment
- Load capacity 60 kg
- Made of conductive powder coated sheet steel
- Colour: light grey (RAL 7035)

For system width [mm]	450	675	900	1.200	1.350	1.800
Dimensions W x D x H [mm]	450 x 200 x 55	675 x 200 x 55	900 x 200 x 55	1200 x 200 x 55	1350 x 200 x 55	1800 x 200 x 55
Depth adjustment range [mm]	67	67	67	67	67	67
Order ref.	42105001.20	42105044.20	42105002.20	42105050.20	42105003.20	42105004.20

For system width [mm]	450	675	900	1.200	1.350	1.800
Dimensions W x D x H [mm]	450 x 350 x 55	675 x 350 x 55	900 x 350 x 55	1200 x 350 x 55	1350 x 350 x 55	1800 x 350 x 55
Depth adjustment range [mm]	217	217	217	217	217	217
Order ref.	42105005.20	42105045.20	42105006.20	42105051.20	42105007.20	42105008.20

Accessories for table set-up

Shelf tray 650 mm depth



- With hooks for suspending in the avero vertical profile
- Raised lip 25 mm all the way round
- Infinitely variable inclination adjustment by +/- 30°
- Infinitely variable depth adjustment
- Load capacity 60 kg
- Made of conductive powder-coated sheet steel
- Colour: light grey (RAL 7035)

For system width [mm]	450	675	900	1.200	1.350	1.800
Dimensions W x D x H [mm]	450 x 650 x 62	675 x 650 x 62	900 x 650 x 62	1200 x 650 x 62	1350 x 650 x 62	1800 x 650 x 62
Depth adjustment range [mm]	194	194	194	194	194	194
Order ref.	42105013.20	42105046.20	42105014.20	42105049.20	42105015.20	42105016.20

Label strip for shelf trays

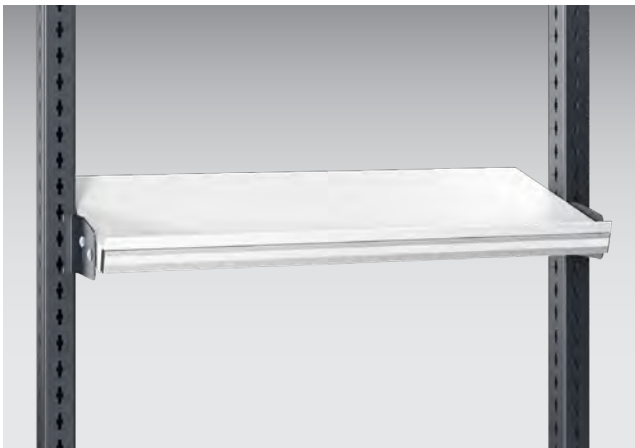

- Downloadable label document templates are available free of charge at www.bott.de/download
- Extruded aluminium profile
- For installation at the front or back
- With inserted paper strip height 16 mm
- Optimised for the installation of pick-to-light modules
- Colour: anodised aluminium

For system width [mm]	450	900	1.200	1.350	1.800
Dimensions W x D x H [mm]	450 x 13 x 35	900 x 13 x 35	1200 x 13 x 35	1350 x 13 x 35	1800 x 13 x 35
Order ref.	41011055.97	41011056.97	41011273.97	41011057.97	41011058.97

Accessories for table set-up

Label strip for shelf trays



- 10 sheets of pre-perforated DIN A4 paper with 12 labelling strips each
- Height strips: 16 mm

Version	Labelling strips 10 sheets DIN A4 landscape format, 12 strips per sheet, height 16 mm
Order ref.	43020001

Cable tray for shelf trays 200 and 350 mm depth

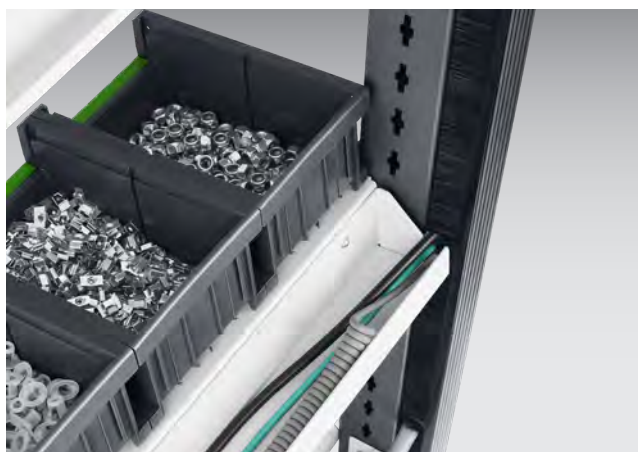

- For installation on the back of the shelf trays 200 mm and 350 mm deep
- Suitable for holding socket strips from the avero range
- Made of conductive powder-coated sheet steel
- Colour: light grey (RAL 7035)

For system width [mm]	450	675	900	1.350	1.800
Dimensions W x D x H [mm]	450 x 66 x 62	675 x 66 x 62	900 x 66 x 62	1350 x 66 x 62	1800 x 66 x 62
Order ref.	42105009.20	42105047.20	42105010.20	42105011.20	42105012.20

Accessories for table set-up

Vanity panel

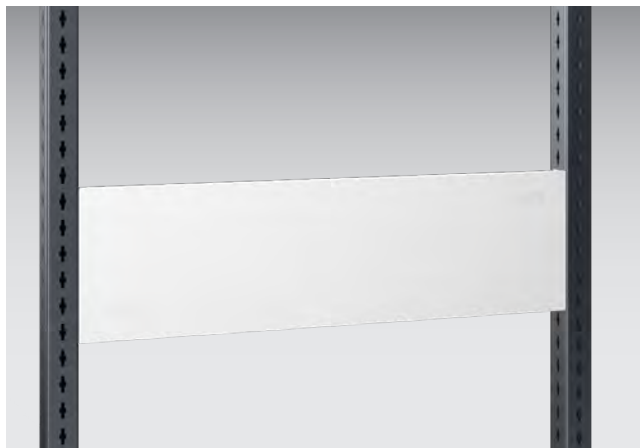

- Available in 2 heights
- For installation on the avero vertical profile
- Made of conductive powder-coated sheet steel
- Colour: light grey (RAL 7035)

For system width [mm]	450	675	900	1.350	1.800
Dimensions W x D x H [mm]	450 x 36 x 240	675 x 36 x 240	900 x 36 x 240	1350 x 36 x 240	1800 x 36 x 240
Order ref.	41011030.20	41011177.20	41011031.20	41011032.20	41011033.20

For system width [mm]	450	675	900	1.350	1.800
Dimensions W x D x H [mm]	450 x 36 x 480	675 x 36 x 480	900 x 36 x 480	1350 x 36 x 480	1800 x 36 x 480
Order ref.	41011034.20	41011178.20	41011035.20	41011036.20	41011037.20

perfo louvred panel with bottBoxes



- Louvred panels with perfo louvred form
- Equipped with service trays of the bottBox series
- For installation on the avero vertical profile
- Load capacity 40 kg
- Made of conductive powder-coated sheet steel
- Colour: light grey (RAL 7035), bottBoxes anthracite grey (RAL 7016)

For system width [mm]	450	675	900	1.350	1.800
Dimensions W x D x H [mm]	450 x 43 x 240	675 x 244 x 240	900 x 43 x 240	1350 x 43 x 240	1800 x 43 x 240
Quantity bottBoxes	3x M1, 3x M2	4x M1; 4x M2	6x M1, 6x M2	10x M1, 10x M2	13x M1, 13x M2
Order ref.	14030181.16	14030213.16	14030182.16	14030183.16	14030184.16

For system width [mm]	450	675	900	1.350	1.800
Dimensions W x D x H [mm]	450 x 43 x 480	675 x 244 x 480	900 x 43 x 480	1350 x 43 x 480	1800 x 43 x 480
Quantity bottBoxes	6x M1, 6x M2	8x M1; 8x M2	12x M1, 12x M2	20x M1, 20x M2	26x M1, 26x M2
Order ref.	14030185.16	14030214.16	14030186.16	14030187.16	14030188.16

Accessories for table set-up

perfo louvred panel with bottBoxes ESD



- Louvred panels with perfo louvred form
- Equipped with service trays of the bottBox series
- For installation on the avero vertical profile
- Load capacity 40 kg
- Made of conductive powder-coated sheet steel
- Colour: light grey (RAL 7035)
- ESD version with conductive bottBoxes (black)

For system width [mm]	450	675	900	1.350	1.800
Dimensions W x D x H [mm]	450 x 43 x 240	675 x 244 x 240	900 x 43 x 240	1350 x 43 x 240	1800 x 43 x 240
Quantity bottBoxes	3x M1, 3x M2	4x M1; 4x M2	6x M1, 6x M2	10x M1, 10x M2	13x M1, 13x M2
Order ref.	14030181.20	14030213.20	14030182.20	14030183.20	14030184.20

For system width [mm]	450	675	900	1.350	1.800
Dimensions W x D x H [mm]	450 x 43 x 480	675 x 244 x 480	900 x 43 x 480	1350 x 43 x 480	1800 x 43 x 480
Quantity bottBoxes	6x M1, 6x M2	8x M1; 8x M2	12x M1, 12x M2	20x M1, 20x M2	26x M1, 26x M2
Order ref.	14030185.20	14030214.20	14030186.20	14030187.20	14030188.20

Accessories for table set-up

perfo louvred panel

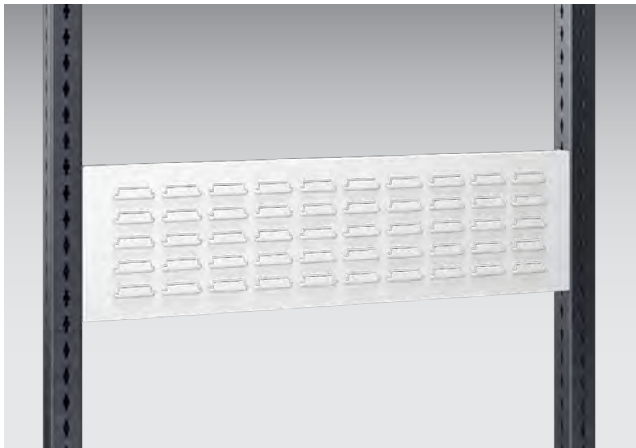

- Available in 2 heights
- With perfo louvred form
- For attaching perfo adapters for holders and accessories from the bott perfo product range as well as shelf boxes and stock boxes
- For installation on the avero vertical profile
- Load capacity 40 kg
- Made of conductive powder-coated sheet steel
- Colour: light grey (RAL 7035)

For system width [mm]	450	675	900	1.350	1.800
Dimensions W x D x H [mm]	450 x 36 x 240	675 x 43 x 240	900 x 36 x 240	1350 x 36 x 240	1800 x 36 x 240
Order ref.	14025360.20	14025388.20	14025361.20	14025362.20	14025363.20

For system width [mm]	450	675	900	1.350	1.800
Dimensions W x D x H [mm]	450 x 36 x 480	675 x 43 x 480	900 x 36 x 480	1350 x 36 x 480	1800 x 36 x 480
Order ref.	14025364.20	14025389.20	14025365.20	14025366.20	14025367.20

perfo combi-panel with bottBoxes



- Right half with 9.2 x 9.2 mm square perforation in 38.1 mm pitch, for the attachment of holders and accessories from the bott perfo range
- Left half with perfo louvred form equipped with service trays from the bottBox series
- For installation on the avero vertical profile
- Load capacity 40 kg
- Made of conductive powder-coated sheet steel
- Colour: combi-panels light grey (RAL 7035), bottBoxes anthracite grey (RAL 7016)

For system width [mm]	900	1.350	1.800	900	1.350	1.800
Dimensions W x D x H [mm]	900 x 43 x 240	1350 x 43 x 240	1800 x 43 x 240	900 x 43 x 480	1350 x 43 x 480	1800 x 43 x 480
Quantity bottBoxes	3x M1, 3x M2	5x M1, 5x M2	6x M1, 6x M2	6x M1, 6x M2	10x M1, 10x M2	12x M1, 12x M2
Order ref.	14030190.16	14030191.16	14030192.16	14030194.16	14030195.16	14030196.16

Accessories for table set-up

perfo combi-panel with bottBoxes ESD



- Right half with 9.2 x 9.2 mm square perforation in 38.1 mm pitch, for the attachment of holders and accessories from the bott perfo range
- Left half with perfo louvred form equipped with service trays from the bottBox series
- For installation on the avero vertical profile
- Load capacity 40 kg
- Made of conductive powder-coated sheet steel
- Colour: combi-panels light grey (RAL 7035)
- ESD version with conductive bottBoxes (black)

For system width [mm]	900	1.350	1.800	900	1.350	1.800
Dimensions W x D x H [mm]	900 x 43 x 240	1350 x 43 x 240	1800 x 43 x 240	900 x 43 x 480	1350 x 43 x 480	1800 x 43 x 480
Quantity bottBoxes	3x M1, 3x M2	5x M1, 5x M2	6x M1, 6x M2	6x M1, 6x M2	10x M1, 10x M2	12x M1, 12x M2
Order ref.	14030190.20	14030191.20	14030192.20	14030194.20	14030195.20	14030196.20

perfo combi-panel

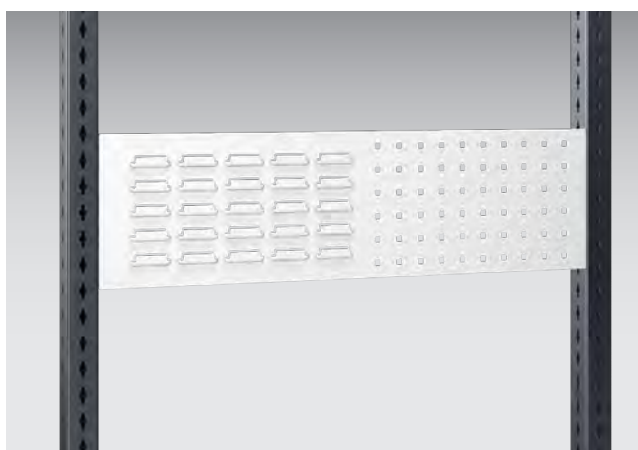

- Right half with 9.2 x 9.2 mm square perforation in 38.1 mm pitch, for the attachment of holders and accessories from the bott perfo range
- Left half with perfo louvred form for attaching perfo adapters for holders and accessories from the bott perfo product range as well as shelf boxes and stock boxes
- For installation on the avero vertical profile
- Load capacity 40 kg
- Made of conductive powder-coated sheet steel
- Colour: light grey (RAL 7035)

For system width [mm]	900	1.350	1.800	900	1.350	1.800
Dimensions W x D x H [mm]	900 x 53 x 240	1350 x 53 x 240	1800 x 53 x 240	900 x 53 x 480	1350 x 53 x 480	1800 x 53 x 480
Order ref.	14025377.20	14025378.20	14025379.20	14025381.20	14025382.20	14025383.20

Accessories for table set-up

perfo perforated panel

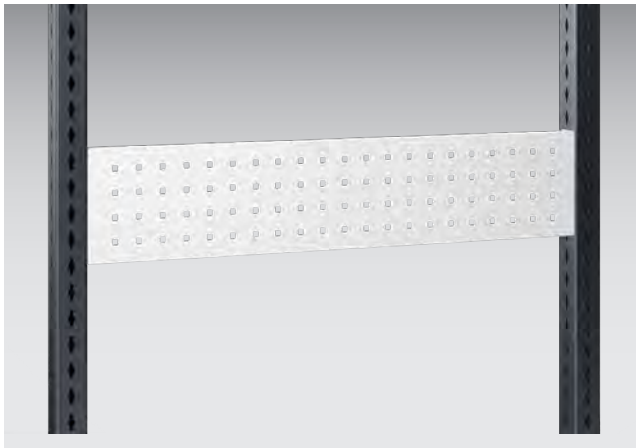

- Available in 3 heights
- 9.2 x 9.2 mm square perforation in 38.1 mm pitch
- For attaching holders and accessories from the bott perfo product range
- For installation on the avero vertical profile
- Load capacity 40 kg
- Made of conductive powder-coated sheet steel
- Colour: light grey (RAL 7035)

For system width [mm]	450	900	1.350	1.800
Dimensions W x D x H [mm]	450 x 36 x 180	900 x 36 x 180	1350 x 36 x 180	1800 x 36 x 180
Order ref.	14025348.20	14025349.20	14025350.20	14025351.20

For system width [mm]	450	675	900	1.350	1.800
Dimensions W x D x H [mm]	450 x 36 x 240	675 x 36 x 240	900 x 36 x 240	1350 x 36 x 240	1800 x 36 x 240
Order ref.	14025340.20	14025386.20	14025341.20	14025342.20	14025343.20

For system width [mm]	450	675	900	1.350	1.800
Dimensions W x D x H [mm]	450 x 36 x 480	675 x 36 x 480	900 x 36 x 480	1350 x 36 x 480	1800 x 36 x 480
Order ref.	14025344.20	14025387.20	14025345.20	14025346.20	14025347.20

Support rail set with bottBoxes

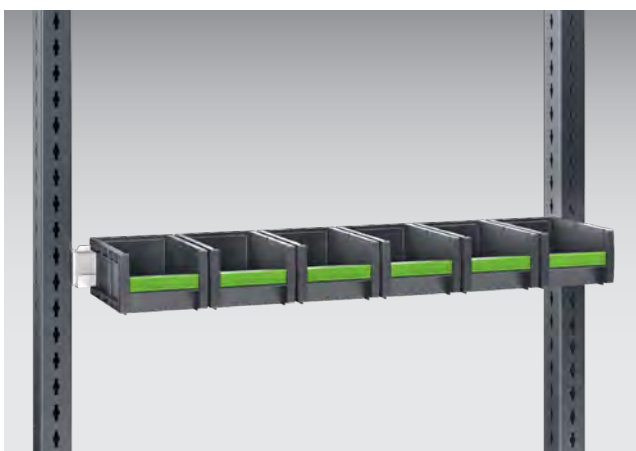

- Equipped with service trays of the bottBox series
- For installation on the avero vertical profile
- Load capacity 25 kg
- Made of conductive powder-coated sheet steel
- Colour: light grey (RAL 7035), bottBoxes anthracite grey (RAL 7016)
- Support rail of system width 675 mm is hooked into the front of the profile

For system width [mm]	450	675	900	1.350
Dimensions W x D x H [mm]	450 x 270 x 90	675 x 150 x 75	900 x 270 x 90	1350 x 270 x 90
Quantity bottBoxes	3x M2	5x M1	6x M2	10x M2
Order ref.	41011040.16	41011181.16	41011041.16	41011042.16

Accessories for table set-up

Support rail set with bottBoxes ESD

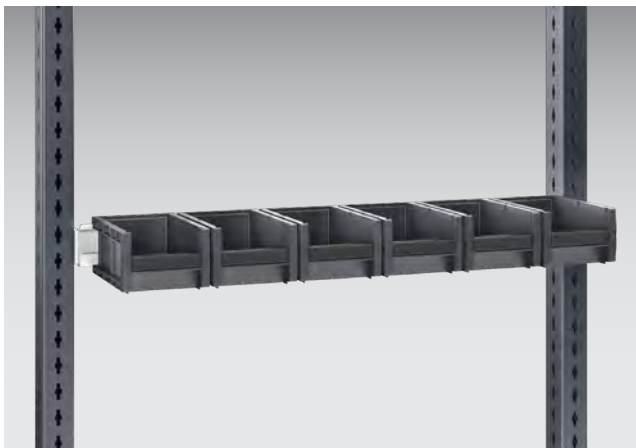

- Equipped with service trays of the bottBox series
- For installation on the avero vertical profile
- Load capacity 25 kg
- Made of conductive powder-coated sheet steel
- Colour: light grey (RAL 7035)
- ESD version with conductive bottBoxes (black)
- Support rail of system width 675 mm is hooked into the front of the profile

For system width [mm]	450	675	900	1.350
Dimensions W x D x H [mm]	450 x 270 x 90	675 x 150 x 75	900 x 270 x 90	1350 x 270 x 90
Quantity bottBoxes	3x M2	5x M1	6x M2	10x M2
Order ref.	41011040.20	41011181.20	41011041.20	41011042.20

Support rail

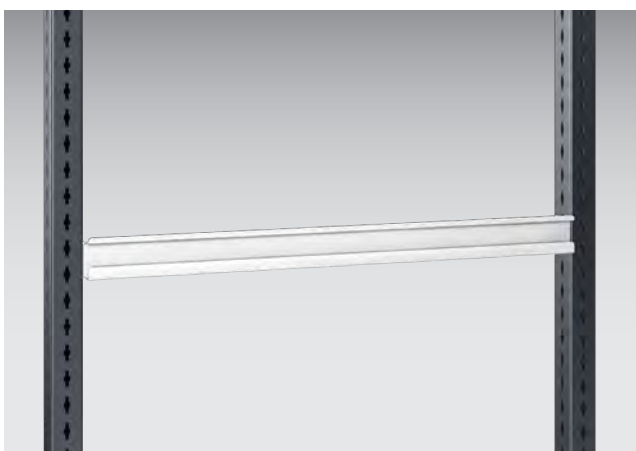

- For installation on the avero vertical profile
- Load capacity 25 kg
- Made of conductive powder-coated sheet steel
- Colour: light grey (RAL 7035)
- Support rail of system width 675 mm is hooked into the front of the profile

For system width [mm]	450	675	900	1.350
Dimensions W x D x H [mm]	450 x 75 x 65	675 x 50 x 65	900 x 75 x 65	1350 x 75 x 65
Order ref.	41011014.20	41011180.20	41011015.20	41011016.20

Accessories for table set-up

Joint rail set with bottBoxes

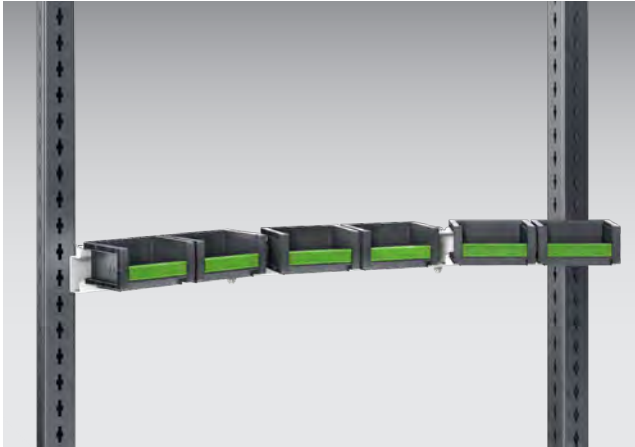

- Equipped with service trays of the bottBox series
- Fixed centre rail, two swivelling outer rails on the left and right for the ergonomic arrangement of service trays at an optimum reaching distance
- Swivel range of the outer rails 45°
- For installation on the avero vertical profile
- Load capacity 25 kg
- Made of conductive powder-coated sheet steel
- Colour: light grey (RAL 7035)
- bottBoxes anthracite grey (RAL 7016)

For system width [mm]	900	1.350
Dimensions W x D x H [mm]	900 x 185 x 75	1350 x 185 x 75
middle rail width [mm]	334	784
outer rail width [mm]	280	280
Quantity bottBoxes	6x M1	9x M1
Order ref.	41011044.16	41011045.16

Joint rail set with bottBoxes ESD



- Equipped with service trays of the bottBox series
- Fixed centre rail, two swivelling outer rails on the left and right for the ergonomic arrangement of service trays at an optimum reaching distance
- Swivel range of the outer rails 45°
- For installation on the avero vertical profile
- Load capacity 25 kg
- Made of conductive powder-coated sheet steel
- Colour: light grey (RAL 7035)
- ESD version with conductive bottBoxes (black)

For system width [mm]	900	1.350
Dimensions W x D x H [mm]	900 x 185 x 75	1350 x 185 x 75
middle rail width [mm]	334	784
outer rail width [mm]	280	280
Quantity bottBoxes	6x M1	9x M1
Order ref.	41011044.20	41011045.20

Accessories for table set-up

Joint rail

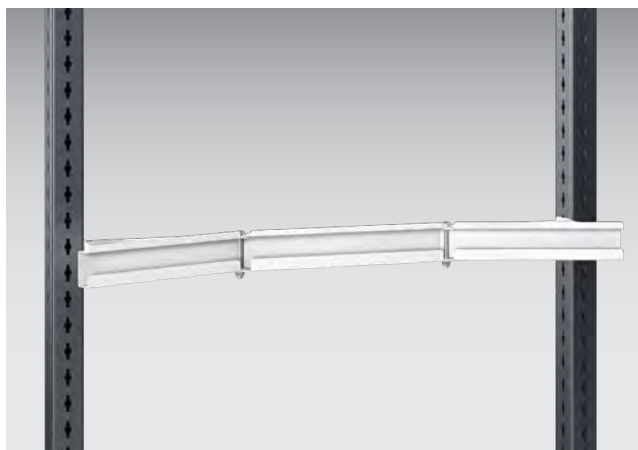

- For attaching shelf boxes and stock boxes
- Fixed centre rail, two swivelling outer rails on the left and right for the ergonomic arrangement of service trays at an optimum reaching distance
- Swivel range of the outer rails 45°
- For installation on the avero vertical profile
- Load capacity 25 kg
- Made of conductive powder-coated sheet steel
- Colour: light grey (RAL 7035)

For system width [mm]	900	1.350
Dimensions W x D x H [mm]	900 x 89 x 65	1350 x 89 x 65
middle rail width [mm]	334	784
outer rail width [mm]	280	280
Order ref.	41011022.20	41011023.20

Grab box



- Sturdy, durable shelf box made of polypropylene
- Easy to clean thanks to smooth inner sides
- bottBoxes of the same width are stackable
- Removable label clip for inserting a paper strip (H = 16 mm)
- Optional label clips in 3 further colours available for colour coding
- Ergonomic recessed grip at the front
- Additional gripping option at the back from size M3
- Strip at the back for suspension in louvred panels
- Possibility of inserting a stock card in bank card format on the back from size M2
- Colour: anthracite grey (RAL 7016)



Description handle box	M1	M2	M3	M4	L3	L4	L5
Dimensions W x D x H [mm]	130 x 100 x 65	130 x 198 x 90	130 x 298 x 165	130 x 398 x 165	264 x 298 x 165	264 x 398 x 165	264 x 498 x 165
Load capacity when suspended (KG)	2	3	5	5	5	5	5
Pack of	48	36	24	12	12	6	6
Order ref.	13022045.19	13022046.19	13022047.19	13022049.19	13022048.19	13022050.19	13022052.19

Grab box ESD



- Sturdy, durable shelf box made of polypropylene
- Easy to clean thanks to smooth inner sides
- bottBoxes of the same width are stackable
- Removable label clip for inserting a paper strip (H = 16 mm)
- Optional label clips in 3 further colours available for colour coding
- Ergonomic recessed grip at the front
- Additional gripping option at the back from size M3
- Strip at the back for suspension in louvred panels
- Possibility of inserting a stock card in bank card format on the back from size M2
- Colour: ESD version black



Description handle box	M1	M2	M3
Dimensions W x D x H [mm]	130 x 100 x 65	130 x 198 x 90	130 x 298 x 165
Load capacity when suspended (KG)	2	3	5
Pack of	48	36	24
Order ref.	13022045.72	13022046.72	13022047.72



bottBox label clip

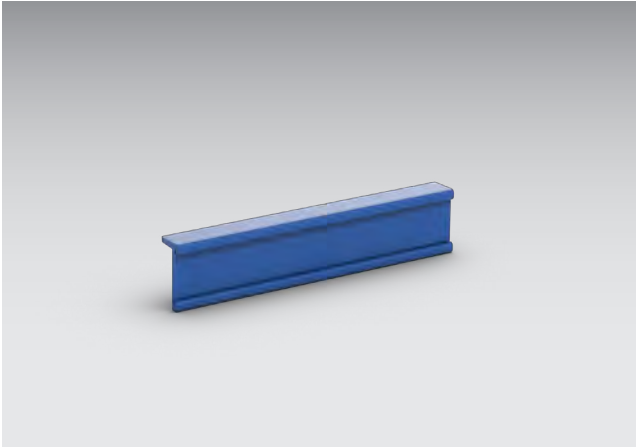

- For colour coding the bottBoxes
- With groove for insertion of a paper strip (H = 16 mm)
- For clipping onto the bottBox body



For use with bottBox	M1, M2, M2X, M3, M3X, M4, M4X	M1, M2, M2X, M3, M3X, M4, M4X	M1, M2, M2X, M3, M3X, M4, M4X
Colour RAL	RAL 5010	RAL 3001	RAL 1023
Colour	Gentian blue	Signal red	Traffic yellow
Dimensions W x D x H [mm]	103 x 11 x 20	103 x 11 x 20	103 x 11 x 20
Weight [kg]	0.14	0.14	0.14
Pack of	36	36	36
Order ref.	13022024.11	13022024.04	13022024.12

bottBox label clip

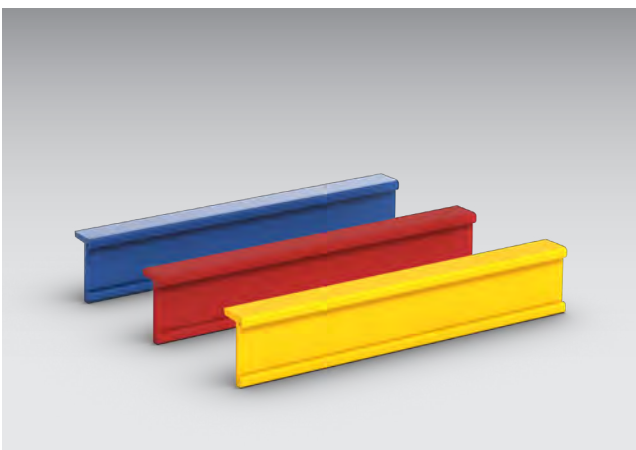

- For colour coding the bottBoxes
- With groove for insertion of a paper strip (H = 16 mm)
- For clipping onto the bottBox body

For use with bottBox	M1, M2, M2X, M3, M3X, M4, M4X
Colour RAL	1023/5010/3001
Dimensions W x D x H [mm]	103 x 11 x 20
Weight [kg]	0.14
Pack of	36
Order ref.	13022025

Divider for boxes

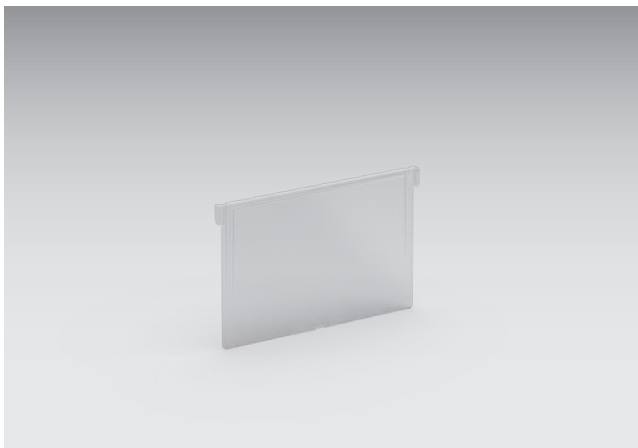

- For dividing the bottBoxes crossways from size M2
- Transparent polycarbonate (PC) makes it easier to see the contents of the rear part of the box
- Colour: transparent
- Pack of 6

For use with bottBox	M2	M2X, M3, M3X, M4, M4X	L3, L3X, L4, L4X, L5
Dimensions W x D x H [mm]	118 x 6 x 68	118 x 6 x 143	252 x 6 x 143
Weight [kg]	0.07	0.28	0.70
Pack of	6	6	6
Order ref.	13022031	13022032	13022033

Viewing window for boxes / dispensers

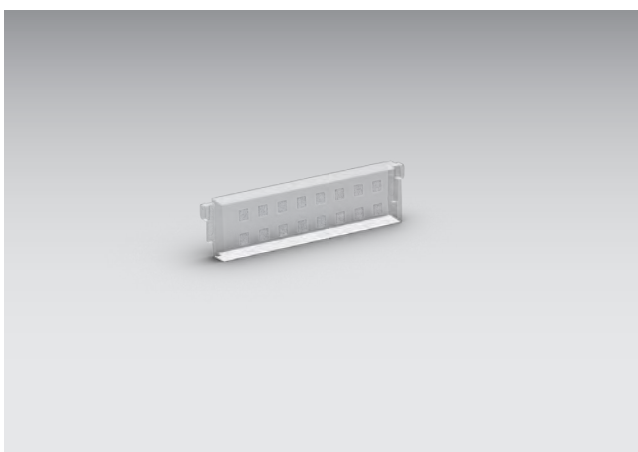

- For insertion on the front of the bottBox
- Turns the service tray into a full-grade storage box with maximum usable storage volume
- Transparent polycarbonate (PC) makes it easier to see the contents of the box
- From size M2, the viewing window may also be used as a dispensing panel, thereby creating ergonomic access in the front area whilst retaining the maximum usable volume in the rear area
- Colour: transparent
- Pack of 6

For use with bottBox	M1, M2	M2X, M3, M3X, M4, M4X	L3, L3X, L4, L4X, L5
Dimensions W x D x H [mm]	118 x 12 x 27	118 x 12 x 88	252 x 12 x 88
Weight [kg]	0.06	0.19	0.40
Pack of	6	6	6
Order ref.	13022028	13022029	13022030

bottBox hinged lid



- For closing up bottBoxes
- Material: PC (Polycarbonate) / Colour: transparent

For use with bottBox	M2	M3
Dimensions W x D x H [mm]	117 x 192 x 4	117 x 276 x 4
Weight [kg]	0.36	0.54
Pack of	6	6
Order ref.	13022184	13022185

Euroboxes



- Containers fit standard europallet sizes
- For all storage, production and transport needs
- Straight walls offer maximum volume with excellent strength
- Optional lids available
- Resistant to numerous acids and alkalis
- Temperature resistance -20 °C to +60 °C, for a short time also up to +90 °C
- Material: Polypropylene
- Colour: anthracite grey



Width [mm]	200	400	400	400	400
Depth [mm]	300	300	300	300	300
Height [mm]	120	120	175	235	320
Weight [kg]	0.42	0.69	0.95	1.15	1.59
Pack of	1	1	1	1	1
Order ref.	62510019.19V	62510013.19V	62510020.19V	62510014.19V	62510015.19V

Euroboxes

Euroboxes



- Containers fit standard europallet sizes
- For all storage, production and transport needs
- Straight walls offer maximum volume with excellent strength
- Optional lids available
- Resistant to numerous acids and alkalis
- Temperature resistance -20 °C to +60 °C, for a short time also up to +90 °C
- Material: Polypropylene
- Colour: anthracite grey



Width [mm]	600	600	600	600
Depth [mm]	400	400	400	400
Height [mm]	120	175	220	320
Weight [kg]	1.17	1.46	1.67	2.52
Pack of	1	1	1	1
Order ref.	62510016.19V	62510021.19V	62510017.19V	62510018.19V

Cover for euroboxes

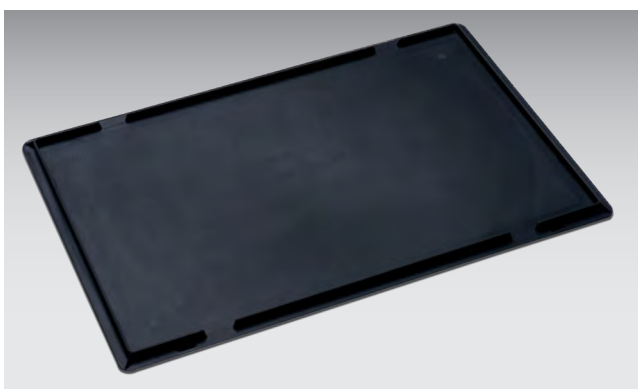

- Containers fit standard europallet sizes
- For all storage, production and transport needs
- Straight walls offer maximum volume with excellent strength
- Optional lids available
- Resistant to numerous acids and alkalis
- Temperature resistance -20 °C to +60 °C, for a short time also up to +90 °C
- Material: Polypropylene
- Colour: anthracite grey

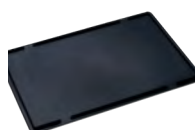

Width [mm]	400	600
Depth [mm]	300	400
Height [mm]	27	27
Weight [kg]	1.17	2.28
Pack of	3	3
Order ref.	12204064	12204065

Swivel arms

Swivel arm with shelf tray which can be rotated & tilted for euronorm box 400 x 300 mm



- Complete set incl. securing bracket, swivel arm and system fixing
- Shelf tray can be turned through 360° and inclined infinitely variable from 0-45°, fixed with clamp lever
- Safety lip at the front
- 3 hinged joints, 2 swivel arms length 350 and 300 mm
- For fastening to the avero vertical profile
- Load capacity 25 kg
- Made of conductive powder-coated sheet steel
- Colour: light grey (RAL 7035)

Dimensions W x D [mm]	315 x 405	415 x 305
Height of shelf tray safety lip [mm]	15	15
Order ref.	41011059.20	41011060.20

Swivel arm with shelf tray which can be rotated & tilted for euronorm box 600 x 400 mm



- Complete set incl. securing bracket, swivel arm and system fixing
- Tray can be turned through 360° and inclined infinitely variable from 0-45°, fixed with clamp lever
- Safety lip all the way round
- 3 hinged joints, 2 swivel arms length 350 and 300 mm
- For installation on the avero vertical profile
- Load capacity 25 kg
- Made of conductive powder-coated sheet steel
- Colour: light grey (RAL 7035)

Dimensions W x D [mm]	610 x 410
Height of shelf tray safety lip [mm]	20
Order ref.	41011062.20

Swivel arms

Swivel arm with rotatable shelf tray



- Complete set incl. securing bracket, swivel arm and system fixing
- Shelf tray can be turned through 360°
- Safety lip all the way round
- 3 hinged joints, 2 swivel arms length 350 and 300 mm
- For installation on the avero vertical profile
- Load capacity 25 kg
- Made of conductive powder-coated sheet steel
- Colour: light grey (RAL 7035)

Dimensions W x D [mm]	500 x 400
Height of shelf tray safety lip [mm]	15
Order ref.	41011061.20

Swivel arm with system frame

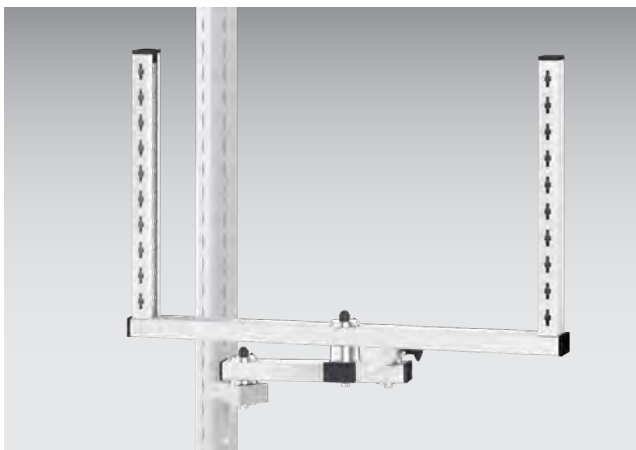

- Complete set incl. securing bracket, swivel arm and system frame
- System frame can be turned through 360°
- 2-sided avero perforation on the side of the frame for attachment of avero accessories with system width 675 mm
- Can be configured on both sides
- 3 hinged joints, 2 swivel arms length 350 and 300 mm
- For installation on the avero vertical profile
- Load capacity 25 kg
- Made of conductive powder-coated sheet steel
- Colour: light grey (RAL 7035)

For system width [mm]	675
Dimensions W x D x H [mm]	675 x 590 x 700
Order ref.	41011186.20

Swivel arms

Swivel frame



- For the ergonomic arrangement of assembly fixing and tools within optimum reach
- 2-sided avero perforation on the side of the frame for attachment of avero accessories with system width 675 mm
- Can be configured on both sides
- Can be swivelled through 0-90°
- Can be fixed with clamp lever
- For installation on the avero vertical profile
- Load capacity 50 kg
- Made of conductive powder-coated sheet steel
- Colour: anthracite grey (RAL 7016)

System width [mm]	675
Dimensions W x D x H [mm]	675 x 53 x 950
Usable height [mm]	920
Order ref.	41011187.19

Swivel frame ESD



- For the ergonomic arrangement of assembly fixing and tools within optimum reach
- 2-sided avero perforation on the side of the frame for attachment of avero accessories with system width 675 mm
- Can be configured on both sides
- Can be swivelled through 0-90°
- Can be fixed with clamp lever
- For installation on the avero vertical profile
- Load capacity 50 kg
- Made of conductive powder-coated sheet steel
- Colour: anthracite grey (RAL 7016)
- ESD version with EMC contact strap

System width [mm]	675
Dimensions W x D x H [mm]	675 x 53 x 950
Usable height [mm]	920
Order ref.	41011187.71

Swivel arms

perfo perforated panel for system and swivel frame profile

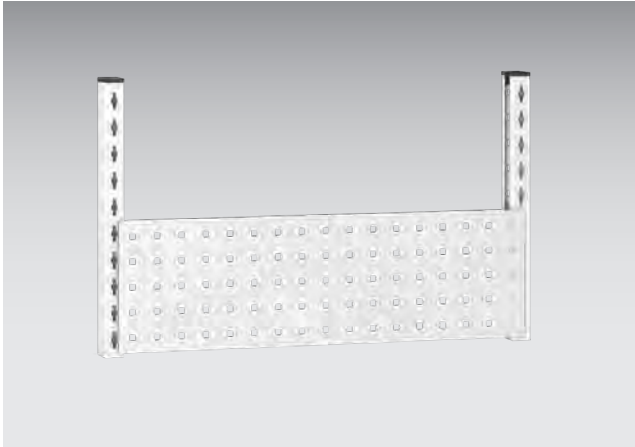

- 9.2 x 9.2 mm square perforation in 38.1 mm pitch
- For attaching holders and accessories from the bott perfo product range
- For suspension in the avero system and swivel frame profile
- Load capacity 15 kg
- Made of conductive powder-coated sheet steel
- Colour: light grey (RAL 7035)

For system width [mm]	675
Dimensions W x D x H [mm]	675 x 20 x 200
Order ref.	14025385.20

Support rail set with bottBoxes for system and swivel frame profile

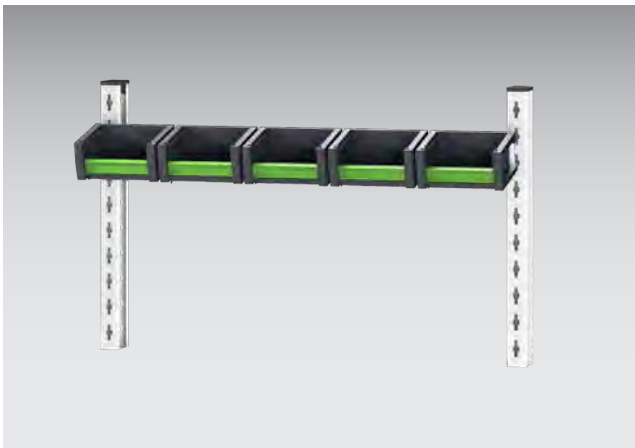

- Equipped with service trays of the bottBox series
- For installation on the avero vertical profile
- Load capacity 25 kg
- Made of conductive powder-coated sheet steel
- Colour: light grey (RAL 7035), bottBoxes anthracite grey (RAL 7016)
- Support rail of system width 675 mm is hooked into the front of the profile

For system width [mm]	675
Dimensions W x D x H [mm]	675 x 150 x 75
Quantity bottBoxes	5x M1
Order ref.	41011181.16

Swivel arms

Support rail set with bottBoxes for system and swivel frame profile ESD



- Equipped with service trays of the bottBox series
- For installation on the avero vertical profile
- Load capacity 25 kg
- Made of conductive powder-coated sheet steel
- Colour: light grey (RAL 7035)
- ESD version with conductive bottBoxes (black)
- Support rail of system width 675 mm is hooked into the front of the profile

For system width [mm]	675
Dimensions W x D x H [mm]	675 x 150 x 75
Quantity bottBoxes	5x M1
Order ref.	41011181.20

Support rail for system and swivel frame profile

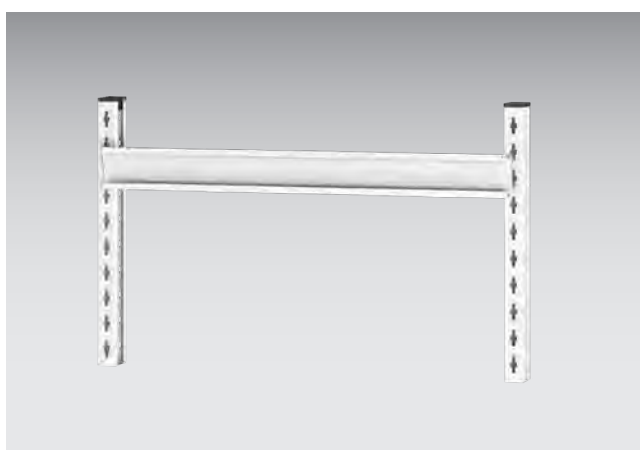

- For installation on the avero vertical profile
- Load capacity 25 kg
- Made of conductive powder-coated sheet steel
- Colour: light grey (RAL 7035)
- Support rail of system width 675 mm is hooked into the front of the profile

For system width [mm]	675
Dimensions W x D x H [mm]	675 x 50 x 65
Order ref.	41011180.20

Accessories for system frame and swivel frame

Shelf tray set with bottBoxes for system, swivel frame profile and parts trolley



- Equipped with service trays of the bottBox series
- With hooks for suspending into the avero vertical profile
- Raised lip on one side 20 mm high, shelf tray can optionally be installed with the raised lip on the front or the back
- Inclination infinitely variable, adjustable +/- 30°
- Infinitely variable depth adjustment
- Load capacity 50 kg
- Made of conductive powder-coated sheet steel
- Colour: light grey (RAL 7035), bottBoxes anthracite grey (RAL 7016)

For system width [mm]	675	675
Dimensions W x D x H [mm]	675 x 200 x 126	675 x 350 x 200
Depth adjustment range [mm]	67	217
Quantity bottBoxes	4 x M2	4 x M3
Order ref.	41011183.16	41011184.16

Shelf tray set with bottBoxes for system, swivel frame profile and parts trolley ESD



- Equipped with service trays of the bottBox series
- With hooks for suspending into the avero vertical profile
- Raised lip on one side 20 mm high, shelf tray can optionally be installed with the raised lip on the front or the back
- Inclination infinitely variable, adjustable +/- 30°
- Infinitely variable depth adjustment
- Load capacity 50 kg
- Made of conductive powder-coated sheet steel
- Colour: light grey (RAL 7035)
- ESD version with conductive bottBoxes (black)

For system width [mm]	675	675
Dimensions W x D x H [mm]	675 x 200 x 126	675 x 350 x 200
Depth adjustment range [mm]	67	217
Quantity bottBoxes	4 x M2	4 x M3
Order ref.	41011183.20	41011184.20

Accessories for system frame and swivel frame

Shelf tray for system, swivel frame profile and parts trolley width 675 mm

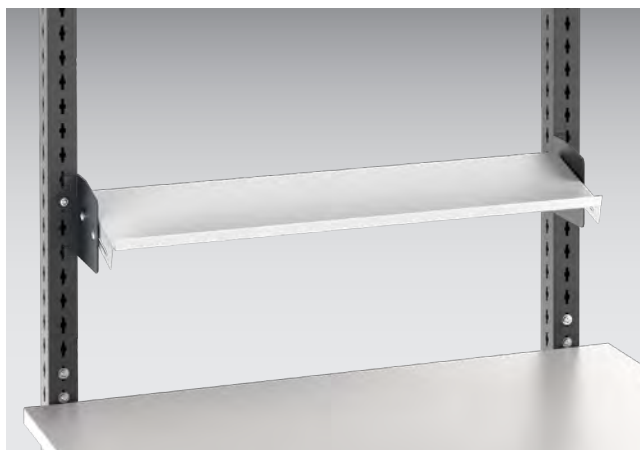

- With hooks for suspending in the avero vertical profile
- Raised lip on one side, 20 mm high
- Shelf tray can optionally be installed with the raised lip on the front or the back
- Inclination continually adjustable by +/- 30°
- Infinitely variable depth adjustment
- Load capacity 50 kg
- Made of conductive powder-coated sheet steel
- Colour: light grey (RAL 7035)

For system width [mm]	675	675
Dimensions W x D x H [mm]	675 x 200 x 55	675 x 350 x 55
Depth adjustment range [mm]	67	217
Order ref.	42105044.20	42105045.20

Shelf tray depth 650 mm – width 675 mm

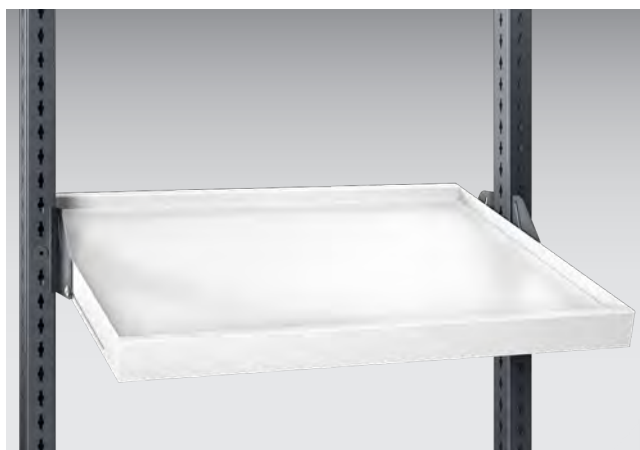

- With hooks for suspending in the avero vertical profile
- Raised lip 25 mm all the way round
- Infinitely variable inclination adjustment by +/- 30°
- Infinitely variable depth adjustment
- Load capacity 60 kg
- Made of conductive powder-coated sheet steel
- Colour: light grey (RAL 7035)

For system width [mm]	675	
Version		Divider, pack of 5
Dimensions W x D x H [mm]	675 x 650 x 62	17 x 611 x 50
Depth adjustment range [mm]	194	
Order ref.	42105046.20	41011225.20

Accessories for system frame and swivel frame

Cable tray for shelf trays width 675 mm



- For installation on the back of the shelf trays 200 mm and 350 mm deep
- Suitable for holding socket strips from the avero range
- Made of conductive powder-coated sheet steel
- Colour: light grey (RAL 7035)

For system width [mm]	675
Dimensions W x D x H [mm]	675 x 66 x 62
Order ref.	42105047.20

Label strip for shelf tray width 675 mm

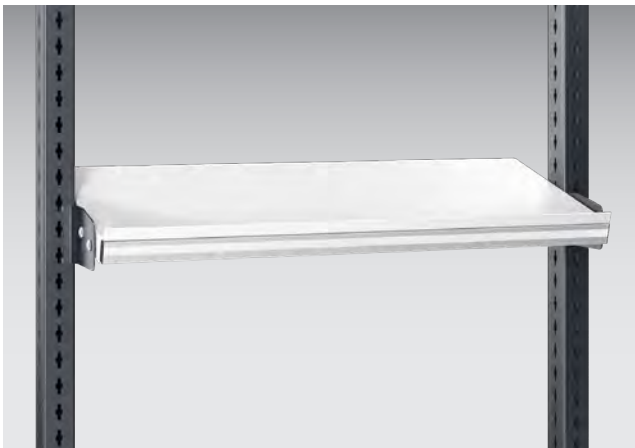

- Downloadable label document templates are available free of charge at www.bott.de/download
- For installation at the front or back
- With inserted paper strip height 16 mm
- Optimised for installation of pick-to-light modules
- Extruded aluminium profile
- Colour: anodised aluminium

For system width [mm]	675
Dimensions W x D x H [mm]	675 x 13 x 35
Order ref.	41011182.97

Accessories for system frame and swivel frame

Label strip for shelf tray width 675 mm labelling strip



- 10 sheets of pre-perforated DIN A4 paper with 12 labelling strips each
- Height strips: 16 mm

Version	Labelling strips 10 sheets DIN A4 landscape format, 12 strips per sheet, height 16 mm
Weight [kg]	0.10
Order ref.	43020001

Rack set 675 mm with bottBoxes



- Equipped with service trays of the bottBox series
- Height-adjustable in 40 mm pitch
- For suspension in the avero system and swivel frame profile
- Load capacity 20 kg
- Made of conductive powder-coated sheet steel
- Colour: light grey (RAL 7035), bottBoxes anthracite grey (RAL 7016)

For system width [mm]	675
Dimensions W x D x H [mm]	675 x 228 x 458
Quantity bottBoxes	15x M2
Order ref.	41011189.16

Accessories for system frame and swivel frame

Rack set 675 mm with bottBoxes ESD



- Equipped with service trays of the bottBox series
- Height-adjustable in 40 mm pitch
- For suspension in the avero system and swivel frame profile
- Load capacity 20 kg
- Made of conductive powder-coated sheet steel
- Colour: light grey (RAL 7035)
- ESD version with conductive bottBoxes (black)

For system width [mm]	675
Dimensions W x D x H [mm]	675 x 228 x 458
Quantity bottBoxes	15x M2
Order ref.	41011189.20

Rack 675 mm



- For three-row assembly with shelf boxes up to max. 195 mm depth
- Height-adjustable in 40 mm pitch
- For suspension in the avero system and swivel frame profile
- Load capacity 20 kg
- Made of conductive powder-coated sheet steel
- Colour: light grey (RAL 7035)

For system width [mm]	675
Dimensions W x D x H [mm]	675 x 211 x 407
Order ref.	41011188.20

Accessories for table base

Footrest

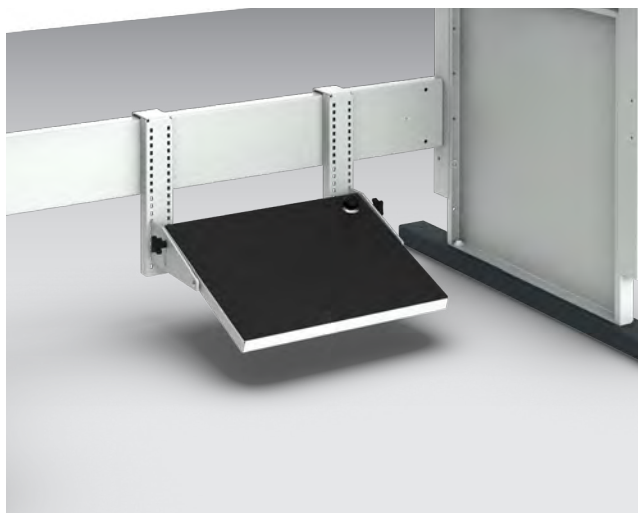

- Ergonomic footrest area 445 x 350 mm (W x D)
- Infinitely-variable foot pedal angle adjustment between 0 to 20
- 210 mm height adjustable in 15 mm increments
- Adjustment range for footrest area is 50-260 mm from the floor
- Meets requirements according to DIN4556
- With slip-resistant, ribbed rubber mat
- Free-standing version with 4 adjustable feet for evening out floor unevenness
- Suspended version with two supports for hanging on bench stringers
- Colour: Light grey metal part (RAL 7035), Black, ribbed, rubber mat
- ESD version with conductive, ribbed, rubber mat, conductive, adjustable feet (freestanding version) and earthing cable (hangable version)

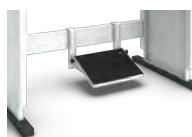

Version	Hangable		Freestanding	
	No	Yes	No	Yes
ESD	No	Yes	No	Yes
Order ref.	41402003.16	41402003.20	41402004.16	41402004.20

Computer holder



- For suspending in the cross brace of the avero table rack
- Base plate for the attachment of computer housings up to a height of 465 mm
- made of stable, conductive powder-coated sheet steel
- Colour: light grey (RAL 7035)

Dimensions W x D x H [mm]	220 x 544 x 134
Order ref.	41011113.20

Accessories for table base

Bin holder



- For fixing on the stringer of base frames
- Suitable for paper and waste bins (max. diameter 260mm / minimum height 185mm)
- Scope does not include waste bin
- Made of conductive powder-coated sheet steel
- Colour: light grey (RAL 7035)

Dimensions W x D x H [mm]	342 x 358 x 314
Order ref.	41011296.20

Universal shelf

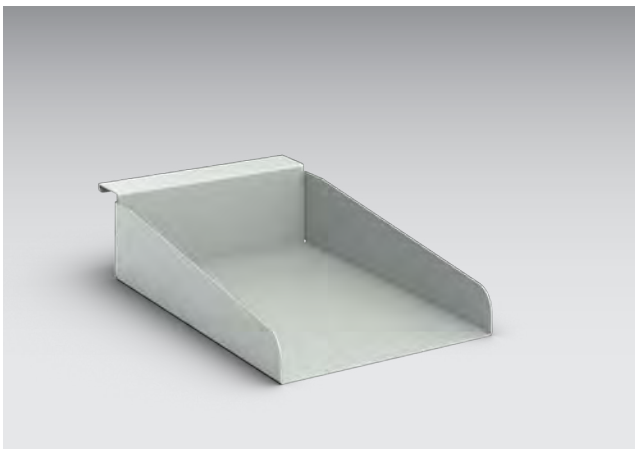

- For suspending in the stringer of the base frames of single workstations, multiple workstations and transport lines
- Load capacity 25 kg
- Made of conductive powder-coated sheet steel
- Colour: light grey (RAL 7035)

Dimensions W x D x H [mm]	215 x 356 x 80
Order ref.	41011297.20

Accessories for table base

Shelf tray bottom for single workstation

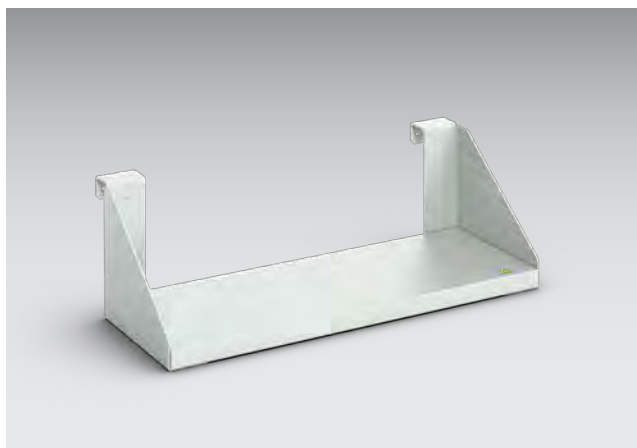

- For suspending in the stringer of the base frames
- Load capacity: 60 kg
- Set consisting of: Melamine film coated worktop, bracket (left+right), fixing kit (4x wood screw / 2x securing screw)

Version	Shelf tray, bottom, for EAP, variable for system width 675 RAL 7035	Shelf tray, bottom, for EAP, variable for system width 900 RAL 7035	Shelf tray, bottom, for EAP, variable for system width 1350 RAL 7035	Shelf tray, bottom, for EAP, variable for system width 1800 RAL 7035
For system width [mm]	675	900	1.350	1.800
Dimensions W x D x H [mm]	100-460x240x216	461-685x240x216	686-1135x240x216	1136-1585x240x216
Order ref.	41011259.16	41011261.16	41011263.16	41011265.16

Version	Shelf tray, bottom, for EAP, variable for system width 675 RAL 7035	Shelf tray, bottom, for EAP, variable for system width 900 RAL 7035	Shelf tray, bottom, for EAP, variable for system width 1350 RAL 7035	Shelf tray, bottom, for EAP, variable for system width 1800 RAL 7035
For system width [mm]	675	900	1.350	1.800
Dimensions W x D x H [mm]	100-460x420x216	461-685x420x216	686-1135x420x216	1136-1585x420x216
Order ref.	41011260.16	41011262.16	41011264.16	41011266.16

Accessories for table base

Shelf tray bottom for single workstation ESD

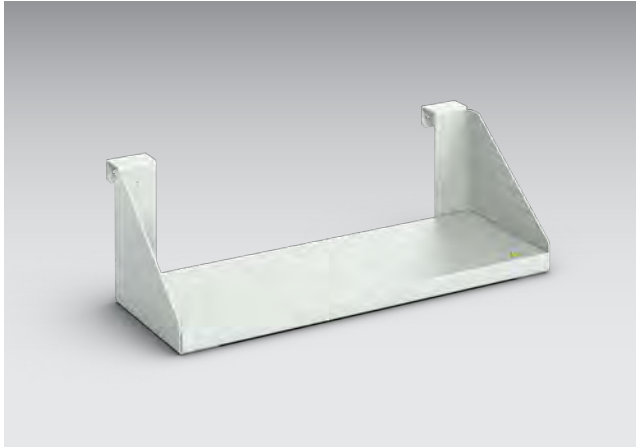

- For suspending in the stringer of the base frames
- Load capacity: 60 kg
- ESD set comprising: Bracket (left+right), fixing kit (4x wood screw + serrated washer / 2x securing screw), cable kit

Version	Shelf tray, bottom, for EAP, variable for system width 675 RAL 7035	Shelf tray, bottom, for EAP, variable for system width 900 RAL 7035	Shelf tray, bottom, for EAP, variable for system width 1350 RAL 7035	Shelf tray, bottom, for EAP, variable for system width 1800 RAL 7035
For system width [mm]	675	900	1.350	1.800
Dimensions W x D x H [mm]	100-460x240x216	461-685x240x216	686-1135x240x216	1136-1585x240x216
Order ref.	41011259.20	41011261.20	41011263.20	41011265.20

Version	Shelf tray, bottom, for EAP, variable for system width 675 RAL 7035	Shelf tray, bottom, for EAP, variable for system width 900 RAL 7035	Shelf tray, bottom, for EAP, variable for system width 1350 RAL 7035	Shelf tray, bottom, for EAP, variable for system width 1800 RAL 7035
For system width [mm]	675	900	1.350	1.800
Dimensions W x D x H [mm]	100-460x420x216	461-685x420x216	686-1135x420x216	1136-1585x420x216
Order ref.	41011260.20	41011262.20	41011264.20	41011266.20

Version	Bracket set for bottom shelf tray for depth 240 RAL 7035	Bracket set for bottom shelf tray for depth 420 RAL 7035
Depth [mm]	240	420
Order ref.	41011267.20	41011268.20

Accessories for table base

Clamping protection for single workstations



- Clamping protection for installation on avero single workstations
- Enables height-adjustable avero single workstations to be placed next to one another without the prescribed safety clearance
- Suitable for left and right-hand side
- Incl. Assembly fixing
- Made of conductive powder-coated sheet steel
- Colour: light grey (RAL 7035)

Dimensions W x D x H [mm]	20 x 600 x 500	20 x 750 x 500	20 x 900 x 500
for depth [mm]	600	750	900
Order ref.	41011255.20	41011256.20	41011257.20

Suspended drawer cabinet ESD



- For installation under avero single workstations, multi-workstations and handling lines
- Optionally with central lock/cubioKey for all drawers or without lock
- Locking cylinder can be changed with cylinder removal key without tools
- Drawers with 100% full extension slide
- Drawer body made of zinc-plated sheet steel
- Load capacity 30 kg per drawer
- Drawer 400 mm high with additional, depth-adjustable small parts tray
- Drawer pull-out lock with variants with lock/cubioKey
- Made of conductive powder-coated sheet steel
- Colour: light grey (RAL 7035)

Version	Without lock	With lock/cubioKey	Without lock	With lock/cubioKey
Drawers [mm]	2x200	2x200	1x400	1x400
Dimensions W x D x H [mm]	225 x 500 x 500	225 x 500 x 500	225 x 500 x 500	225 x 500 x 500
Order ref.	40033013.20	40033014.20	40033015.20	40033016.20

Accessories for table base

Suspended drawer cabinet ESD



- For installation under avero single workstations, multi-workstations and handling lines
- Optionally with central lock/cubioKey for all drawers or without lock
- Locking cylinder can be changed with cylinder removal key without tools
- Drawers with 100% full extension slide
- Drawer body made of zinc-plated sheet steel
- Load capacity 30 kg per drawer
- Drawer pull-out lock with variants with lock/cubioKey
- Made of conductive powder-coated sheet steel
- Colour: light grey (RAL 7035)

Version	Without lock	With lock/cubioKey	Without lock	With lock/cubioKey
Drawers [mm]	2x100	2x100	1x200	1x200
Dimensions W x D x H [mm]	375 x 500 x 300	375 x 500 x 300	375 x 500 x 300	375 x 500 x 300
Order ref.	40033017.20	40033018.20	40033019.20	40033020.20

Suspended drawer cabinet ESD



- For installation under avero single workstations, multi-workstations and handling lines
- Optionally with central lock/cubioKey for all drawers or without lock
- Locking cylinder can be changed with cylinder removal key without tools
- Drawers with 100% full extension slide
- Drawer body made of zinc-plated sheet steel
- Load capacity 30 kg per drawer
- Drawer pull-out lock with variants with lock/cubioKey
- Made of conductive powder-coated sheet steel
- Colour: light grey (RAL 7035)

Version	Without lock	With lock/cubioKey	Without lock	With lock/cubioKey
Drawers [mm]	4x100	4x100	2x200	2x200
Dimensions W x D x H [mm]	375 x 500 x 500	375 x 500 x 500	375 x 500 x 500	375 x 500 x 500
Order ref.	40033021.20	40033022.20	40033023.20	40033024.20

Accessories for table base

cubio suspended drawer cabinet



- Intelligent drawer blocking mechanism prevents more than one drawer opening at once
- Mechanical cabinet lock with 5-pin interchangeable cylinder for optional locking system design
- All drawers supplied with full extension slide, 100% extension and 40 mm overextension
- Standard duty slide with 75 kg load capacity
- Ergonomic bow handle with access from above and below
- Colour: light grey (RAL 7035)

Version	1x 150 mm drawer	1x 300 mm drawer	2x 150 mm drawer	2x 75 mm drawer + 1x 150 mm drawer
Drawers [mm]	1x150	1x300	2x150	2x75, 1x150
Dimensions W x D x H [mm]	525 x 525 x 250	525 x 525 x 400	525 x 525 x 400	525 x 525 x 400
Order ref.	40010001.16V	40010126.16V	40010005.16V	40010106.16V

Suspended drawer cabinet cubio ESD



- Intelligent drawer blocking mechanism prevents more than one drawer opening at once
- Mechanical cabinet lock with 5-pin interchangeable cylinder for optional locking system design
- All drawers supplied with full extension slide, 100% extension and 40 mm overextension
- ESD version all drawers with partial extension 93% and 100 kg load capacity
- Standard duty slide with 75 kg load capacity
- Ergonomic bow handle with access from above and below
- Colour: light grey (RAL 7035)

Version	1x 150 mm drawer	1x 300 mm drawer	2x 150 mm drawer	2x 75 mm drawer + 1x 150 mm drawer
Drawers [mm]	1x150		2x150	2x75, 1x150
Dimensions W x D x H [mm]	525 x 525 x 250	525 x 525 x 400	525 x 525 x 400	525 x 525 x 400
Order ref.	40010001.20V	40010126.20V	40010005.20V	40010106.20V

Accessories for table base

Small parts storage boxes kit suitable for suspended cabinet width 225 x depth 500 mm

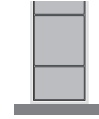
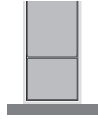

Quantity small parts storage boxes 100x150 [mm]		1
Quantity small parts storage boxes 125x150 [mm]	1	
Quantity small parts storage boxes 150x150 [mm]		2
Quantity small parts storage boxes 150x275 [mm]	1	
Front height of drawer [mm]	starting from 100	starting from 100
height of the small parts storage boxes [mm]	75	75
Order ref.	43020611	43020612

Small parts storage boxes kit suitable for suspended cabinet width 375 x depth 500 mm

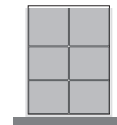
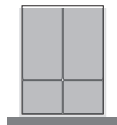

Quantity small parts storage boxes 125x150 [mm]	2	4
Quantity small parts storage boxes 150x150 [mm]		2
Quantity small parts storage boxes 150x275 [mm]	2	
Front height of drawer [mm]	starting from 100	starting from 100
height of the small parts storage boxes [mm]	75	75
Order ref.	43020613	43020614

Dividers and cross dividers kit suitable for suspended cabinet width 375 x depth 500 mm

Quantity of cross dividers	2
Height of the cross dividers [mm]	100
Order ref.	43020621

Accessories for table base

Swivel castor set for cubio drawer cabinet depth 525 mm



- 2 cross members for installation under the cubio drawer cabinets 525 x 525 mm
- 4 swivel castors diameter 75 mm
- Colour: cross members anthracite grey powder-coated (RAL 7016), swivel castors black

Dimensions W x D x H [mm]	525 x 525 x 100
Order ref.	41430082.19

Swivel castor set for cubio drawer cabinet depth 525 mm ESD



- 2 cross members for installation under the cubio drawer cabinets 525 x 525 mm
- 4 swivel castors diameter 75 mm
- Colour: cross members anthracite grey conductive powder-coated (RAL 7016), swivel castors black
- ESD version with conductive swivel castors

Dimensions W x D x H [mm]	525 x 525 x 100
Order ref.	41430082.71

Accessories

Monitor swivel arm

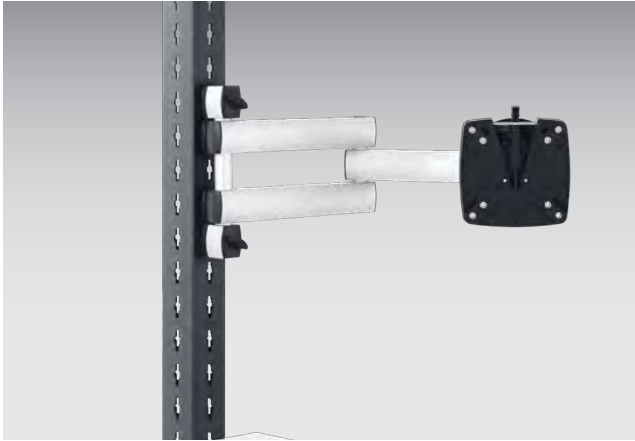

- Reinforced, two-piece articulated arm with a range of 505 mm
- Ball head joint for the flexible tilting and rotation of the monitor
- Removable monitor support plate with VESA 75/100 mount
- For monitors with a weight up to 15 kg
- For fastening to the avero vertical profile
- Colour: Anodised aluminium



Version	Monitor swivel arm	Adapter plate APS profile
Dimensions W x D x H [mm]	130 x 500 x 130	34 x 12 x 216
Weight [kg]	1.73	0.15
Order ref.	41011087	41011167.20
Price £	485.54	

Monitor holder, short

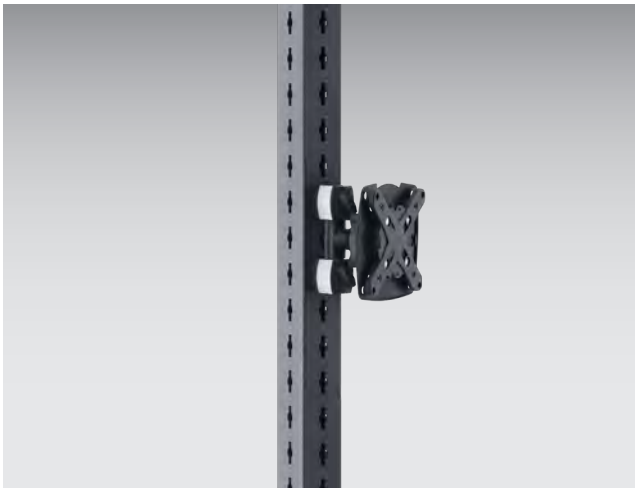

- Ball head joint for the flexible tilting and rotation of the monitor
- Removable monitor support plate with VESA 75/100 mount
- For monitors with a weight up to 15 kg
- For fastening to the avero vertical profile
- Colour: Anodised aluminium



Version	Monitor holder, short	Adapter plate APS profile
Dimensions W x D x H [mm]	130 x 110 x 130	34 x 12 x 216
Weight [kg]	0.72	0.15
Order ref.	41011086	41011167.20
Price £	300.37	

Accessories

perfo monitor holder, short



- Removable monitor support plate with VESA 75/100 mount
- Flexibly tilt and rotate the monitor
- For monitors with a weight up to 10 kg
- For fastening to perfo perforated panels
- Colour: anthracite grey (RAL 7016)



Dimensions W x D x H [mm]	128 x 72 x 172
Order ref.	41011163

Tablet holder

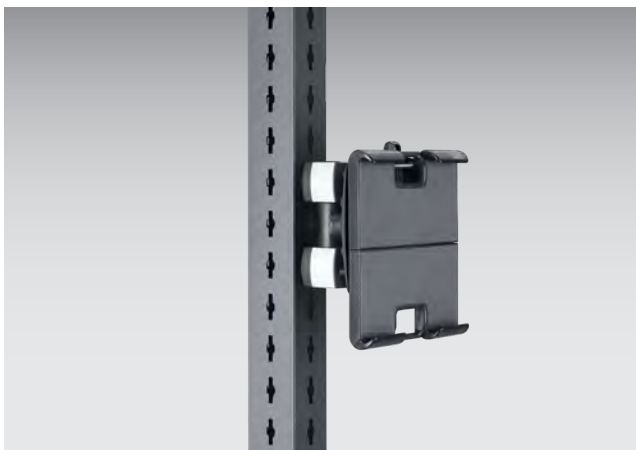

- Plastic holder for tablets with sizes between 7 and 10 inches (clamping length: 160-330mm)
- For attaching to the monitor swivel arm, a short monitor holder or short perfo monitor holder
- Supplied without monitor holder
- Load capacity 0.75 kg
- Colour: black

Dimensions W x D x H [mm]	153 x 42 x 175
Weight [kg]	0.20
Order ref.	41011192

Accessories

Keyboard holder for monitor swivel arm and monitor holder



- For fastening to modular support plates
- Tray surface 640 x 200 mm (WxD)
- Colour: light grey (RAL 7035)

Dimensions W x D x H [mm]	640 x 185 x 460
ESD	Yes
Weight [kg]	2.10
Order ref.	42105024.20

Swivel arm for keyboard

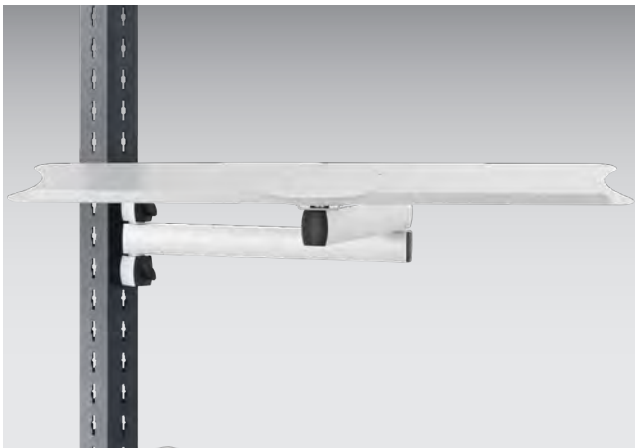

- Two-piece articulated arm with a range of 505 mm
- Tilting and rotating tray, surface area 640 x 172 mm (WxD)
- Load capacity 10 kg
- Colour: Anodised aluminium/silver



Dimensions W x D x H [mm]	640 x 170 x 20
Weight [kg]	2.50
Order ref.	41011085

Accessories

Keyboard drawer



- For holding a standard PC keyboard
- For installation on the stringers of the avero base frame
- Ergonomic palm rest
- Housing made of sheet steel
- Keyboard drawer made of plastic
- Load capacity 5 kg
- Colour: light grey

Dimensions W x D x H [mm]	560 x 400 x 100
Usable surface area for keyboard	525 x 250 x 75
Order ref.	40519010

Storage space



- For holding DIN A4 files or PC
- For installation on the avero vertical profile (side or back) and perforated panels
- Made of conductive powder-coated sheet steel
- Colour: light grey (RAL 7035)
- Incl. assembly fixing
- Note that the useful depth of the storage space is reduced in the case of installation on the side of the avero profile

Dimensions W x D x H [mm]	110 x 340 x 340
Order ref.	42105036.20

Accessories

Drawing holder



- Clipboard for documents up to DIN A4 format
- Spring-supported articulated arms
- Height-adjustable rule
- For fastening to the table top or, optionally, to the avero vertical profile
- Colour: light grey (RAL 7035)

Dimensions W x D x H [mm]	240 x 40 x 320	50 x 110 x 165
ESD	No	No
Weight [kg]	1.52	0.75
Order ref.	81005004	41011088.19

Display panel system with holder



- Holder system with 10 transparent hinged panels for the dirt-free storage of information sheets
- Suitable for holding DIN A4 sheets in portrait format
- For fastening to the avero vertical profile
- Colour: Stainless-steel holder, red swivelling panel frame
- ESD version with black swivelling panel frame

Dimensions W x D x H [mm]	80 x 240 x 393	100 x 240 x 420
ESD	No	Yes
Weight [kg]	0.62	0.62
Order ref.	41011089	41011151

Accessories

Pneumatics



- For installation on perfo perforated panels
- Input quick-action coupling G1/4"
- Outlet quick-action coupling 2x G1/4"



Version	Supply unit, pressure regulator, filter, lubrication	Distribution List
Order ref.	80002001	80001007

Balancer



- For hanging on the carriage snap hooks of the avero overhead rail



Version	Balancer with hose pull	Balancer with cable pull
Load capacity [kg]	0.5 to 1.5	1.0 to 2.0
Order ref.	80003001	80003002

Accessories

ESD accessories



- ESD earthing box - (earth bonding point)
- Plastic box with three front snap fastener connections in front, 10 mm diameter
- 1 Mohm safety resistor per snap fastener connection
- 2 m connecting line with ring connector, 4 mm diameter



Version	Earthing box	Wristband with spiral cable
Dimensions W x D x H [mm]	79 x 40 x 25	0 x 0 x 0
Order ref.	50001026.90	50810010

Turntable



- Stainless steel plate with ribbed rubber mat
- ESD version: conductive rubber coating and earthing cable
- Load capacity: 180 kg
- Version with locking mechanism with locking bolt in 45° increments, plate will rotate freely if required

Dimensions Ø x H [mm]	380 x 20				500 x 20			
ESD	No		Yes		No		Yes	
Version	Without locking mechanism	With locking mechanism	without locking mechanism	With locking mechanism	Without locking mechanism	With locking mechanism	Without locking mechanism	With locking mechanism
Order ref.	08010036.96	08010035.96	08010056.20	08010055.20	08010034.96	08010009.96	08010054.20	08010053.20

Turntable with foot operation

Dimensions Ø x H [mm]	380 x 20		500 x 20		380 x 155	500 x 155
ESD	Yes	No	Yes	No		
Version	With locking mechanism				Retrofit kit	
Order ref.	08010110.20	08010110.96	08010111.20	08010111.96	08010112.19	08010113.19

Accessories

LED articulated arm lamps



- Spring-balanced rod system, length 400 + 385 mm
- Ergonomically shaped tommy screw for adjustment without tools
- 3D joint for rotating and swivelling the lamp body
- Conical prism screen for glare-free working and a homogeneous illuminated area
- Especially energy-saving LED modules
- Neutral white 4000 Kelvin
- Adaptor for mounting to avero vertical profile with swivel pins for swivelling the lamp
- Optional with additional swivel arm length 350 mm plus additional hinged joint
- Colour: anodised aluminium
- UK version with additional adapter for Schuko plug to UK plug

Version	With avero adaptor	With avero adaptor and swivel arm	With adapter UK version	With adapter with swivel arm UK version
Illumination level at a distance of 50 cm [lx]	2.500	2.500	2.500	2.500
Illumination level (maximum value)	3.053	3.053	3.053	3.053
Lamp	31 W LED	31 W LED	31 W LED	31 W LED
Order ref.	50502072	50502075	50502088	50502089

LED articulated arm magnifier lamp, dimmable



- Spring-balanced rod system, length: 402 + 421 mm
- Ergonomically shaped tommy screw for adjustment without tools
- 2D joint for rotating the lamp body
- Especially energy-saving, dimmable LED modules
- Light colour: neutral white 5000 Kelvin
- Plastic magnifying glass with 3.5 dioptres
- Large visual range with 160 mm diameter
- Colour: Anodised aluminium

Version	With clamped base	With avero adaptor	With avero adaptor and swivel arm
Illumination level at a distance of 15 cm [lx]	7.000	7.000	7.000
Illumination level (maximum value)	7.457	7.457	7.457
Lamp	12 W LED	12 W LED	12 W LED
Order ref.	50502096	50502097	50502098

Accessories

Cup holder

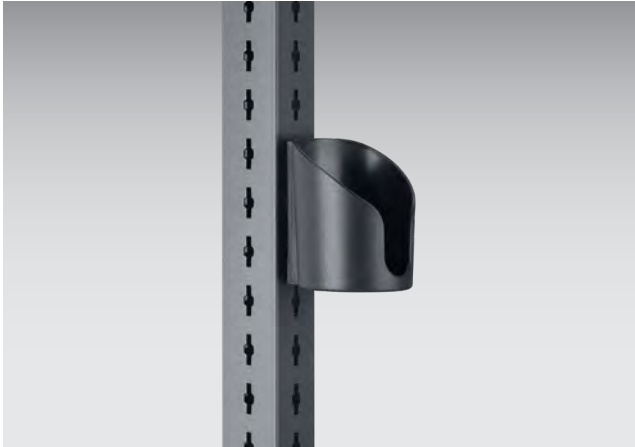

- For mounting on the avero profile or perforated panel
- A closed-floor design for attachment of bottles, cups and containers up to 90 mm in diameter
- An open-floor design for attachment of small power tools
- Material: glass-fibre reinforced plastic



Version	Closed bottom	Open bottom
Dimensions W x D x H [mm]	100 x 106 x 118	100 x 106 x 118
Order ref.	14011033	14011031

Bottle holder



- For holding bottles of up to 96 mm in diameter and Tetra-Pak containers
- For fastening to the avero vertical profile
- Material: zinc-plated steel

Ø [mm]	96
Height [mm]	162
Order ref.	14021058

Accessories

Scanner holder



- Suitable for all standard hand-held scanners
- For installation on perfo perforated panels
- Made of conductive powder-coated sheet steel
- Colour: light grey (RAL 7035)

Dimensions W x D x H [mm]	94 x 100 x 100
Order ref.	41011025.20

perfo power tool holder



- Power tool holder/cartridge holder/can holder made of flexible silicone with powerful neodymium magnet
- Makes screwless and flexible fixing on magnetic surfaces possible
- Diameter: 70 mm



Dimensions W x D x H [mm]	70 x 75 x 28
Weight [kg]	0.03
Order ref.	14021059.10V

Accessories

Industrial chair



- Seat height adjustment with high-quality gas strut
- Seat adjustable in inclination and depth, rounded front seat edge for reduced compressive load
- Backrest with permanent contact function, adjustable in height and inclination, reduced backrest width in upper area for optimal freedom of movement
- Seat and backrest upholstery elements optimally adapted to the anatomy of the body, with hard-wearing, breathable cover fabric that can be replaced at any time
- Five-star base, optionally available with sliding bases or castors
- Version with greater height-adjustment range, additionally with height-adjustable, foldable climbing aid
- ESD version with conductive cover fabric, volume-conducting, black plastic parts and conductive swivel castors
- Colour: Aluminium star base black, plastic elements basalt grey, fabric anthracite



Version	Castors		Slides / with climbing aid		Sliding bases	
Height adjustment range [mm]	450-620		590-870		450-620	
ESD	No	Yes	No	Yes	No	Yes
Order ref.	88601062.90	88601065.90	88601064.90	88601067.90	88601063.90	88601066.90

FIFO shelf

Mobile FIFO shelf



- For provision of materials at the workplace
- Can be configured individually with shelf trays or roller tracks
- Robust base frame with 4 swivel castors, diameter 100 mm, 2 with brakes
- Load capacity 210 kg
- Made of conductive powder-coated sheet steel
- Colour: anthracite grey (RAL 7016)

For system width [mm]	900	
Dimensions W x D x H [mm]	900 x 1045 x 1795	
ESD	No	Yes
Order ref.	41007056.19	41007056.71

Shelf tray for mobile FIFO shelf



- For installation in the mobile FIFO shelf
- Load capacity 60 kg
- Made of conductive powder-coated sheet steel
- Colour: light grey (RAL 7035)
- Divider for shelf tray
- Suitable for shelf trays with depth 1045 mm
- For the creation of a small parts depot
- Made of conductive powder-coated sheet steel
- Colour: light grey (RAL 7035)
- Pack of 5

Version	Shelf tray for mobile FIFO shelf	Divider for shelf tray, pack of 5
System width [mm]	900	
Dimensions W x D x H [mm]	900 x 1045 x 62	17 x 1006 x 50
Order ref.	42105042.20	41011226.20

FIFO shelf

Base shelf for mobile FIFO shelf



- For installation on the base frame of the mobile FIFO shelf
- Load capacity 100 kg
- Made of conductive powder-coated sheet steel
- Colour: anthracite grey (RAL 7016)

For system width [mm]	900
Dimensions W x D x H [mm]	900 x 1045 x 28
Order ref.	42105040.71

System packing table with roll dispenser and cutter



- 2 height-adjustable legs
- Table height with assembled foot elements adjustable via 20 mm hole increments
- Melamine-coated worktop, light grey
- Bottom roll dispenser
- Cutter with cut width 1260 mm
- Shelf with 5 division hoops with a 250 mm gap for clearly dividing folding boxes and other shipping and packaging material.
- perfo perforated panel with storage tray and bin rails for bottBoxes
- Colour: anthracite powder-coated (RAL 7016) leg and vertical profile, light grey powder-coated (RAL 7035) perfo perforated panel

Dimensions W x D x H [mm]	1350 x 750 x 2190
Dimensions Worktop W x D x H [mm]	1.500 x 750 x 30
Order ref.	41032015.19

System packing table

Cutter

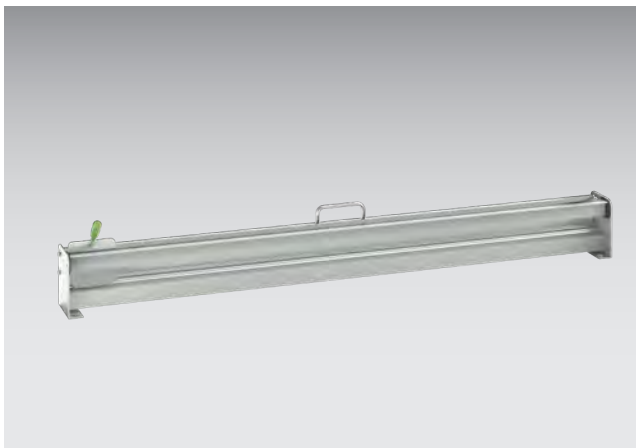

- With blade
- For installation on the worktop
- Suitable for use with paper and cardboard
- Incl. clamping rail for holding the packaging material in place
- Cutting width: max. 1240 mm
- Colour: light grey powder-coated (RAL 7035)

Dimensions W x D x H [mm]	1400 x 115 x 230
Order ref.	07002253.16

Roll dispenser top

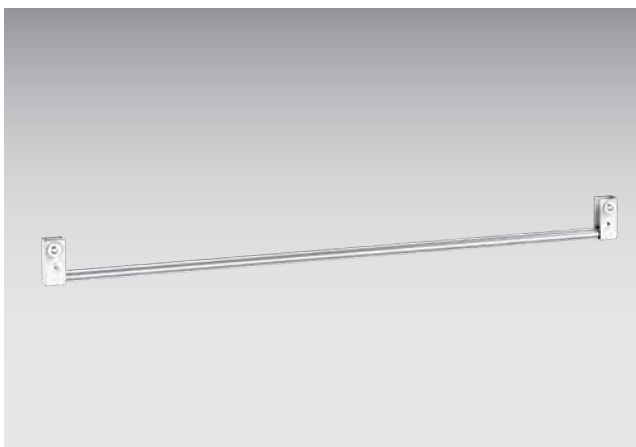

- Mounting shaft incl. holder for fixing to the vertical profile
- Roll width max. 1000mm
- Without side flange
- Load capacity 45 kg
- Light grey conductive powder-coated (RAL 7035)

Dimensions W x D x H [mm]	1400 x 35 x 100
Order ref.	07002250.16

System packing table

Bottom roll dispenser

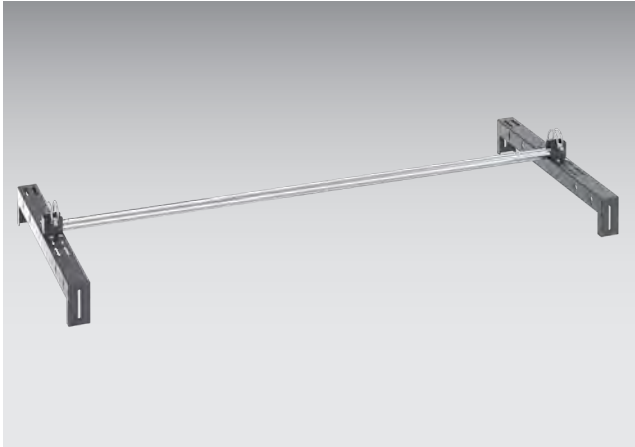

- Mounting shaft incl. holder for installation on the base elements
- Roll width max. 1000 mm
- Roll diameter max. 600 mm
- Without side flange
- Load capacity 45 kg
- Anthracite grey conductive powder-coated (RAL 7016)

Worktop depth (mm)	1400
Dimensions W x D x H [mm]	1.397 x 87 x 72
Order ref.	07002249.19

Fixing element for roll dispenser

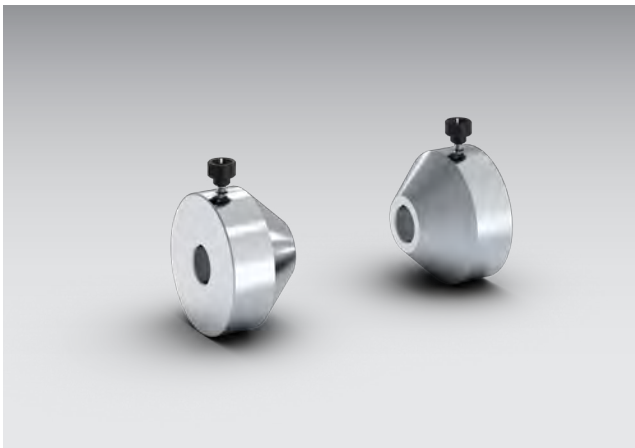

- For fixing and centring the packaging material on the mounting shaft
- Inner diameter of the packaging rolls: 50-90 mm
- Material: Plastic
- VE2

Dimensions W x D x H [mm]	65 x 95 x 95
Order ref.	80833428

System packing table

Clamping rail

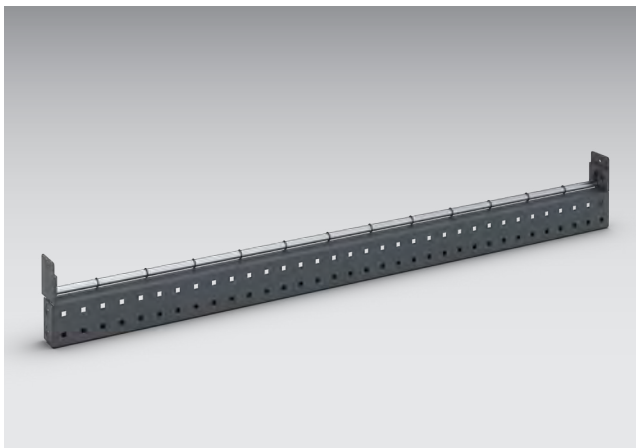

- For holding the packaging material in place for use with the cutter and a roll dispenser at the top and bottom
- For installation between the avero vertical profiles
- Bar made of galvanised sheet steel
- Colour: light grey conductive powder-coated (RAL 7035)

Dimensions W x D x H [mm]	1350 x 60 x 155
Order ref.	07002251.16

Shelf tray with dividers

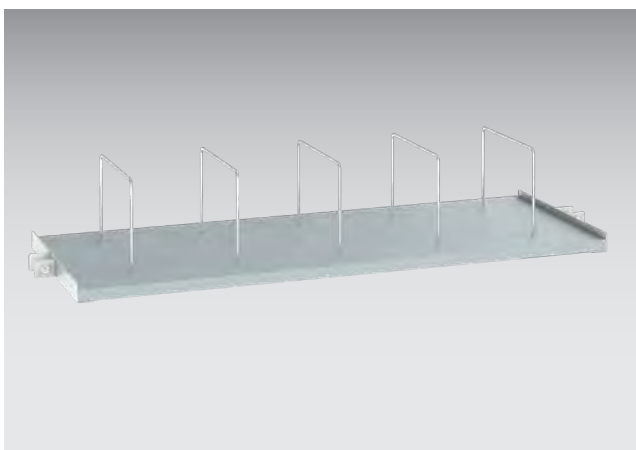

- Laminated wooden shelf with 5 dividers for the clear division of flat packed boxes, as well as other shipping and packaging materials
- The spacing between the dividers is 250mm

Dimensions W x D x H [mm]	1350 x 500 x 30
Order ref.	42105041.01

Mobile systems

Parts trolley with perfo perforated panels



- For the provision of tools and auxiliary equipment at work
- Robust base frame with swivel castors, diameter 100 mm, 2 with brakes
- Available in 2 heights
- 2 vertical profiles installed in the centre of the base unit
- Assembly with perfo perforated panels on both sides
- Total load bearing capacity 200 kg
- Colour: frame anthracite grey (RAL 7016), perfo perforated panels light grey (RAL 7035)

The workstation system

System width [mm]	675	675	900	900	1.350	1.350
Dimensions W x D x H [mm]	675 x 675 x 1315	675 x 675 x 1795	900 x 675 x 1315	900 x 675 x 1795	1350 x 675 x 1315	1350 x 675 x 1795
Dimensions of perfo perforated panels W x D [mm]	621 x 480	621 x 480	848 x 480	848 x 480	1.298 x 480	1.298 x 480
perfo perforated panels	4	6	4	6	4	6
ESD	No	No	No	No	No	No
Order ref.	41014032.16	41014031.16	41014012.16	41014011.16	41014014.16	41014013.16

Parts trolley with perfo perforated panels ESD



- For the provision of tools and auxiliary equipment at work
- Robust base frame with swivel castors (diameter - 100 mm), 2 with brakes
- Available in 2 heights
- Avero vertical profiles mounted in the centre of the floor unit
- Double-sided assembly with perfo perforated panels
- Total load bearing capacity 200 kg
- ESD version with conductive powder coating and conductive swivel castors
- Colour: Frame anthracite grey (RAL 7016), perfo perforated panel light-grey (RAL 7035)

System width [mm]	675	675	900	900	1.350	1.350
Dimensions W x D x H [mm]	675 x 675 x 1315	675 x 675 x 1795	900 x 675 x 1315	900 x 675 x 1795	1350 x 675 x 1315	1350 x 675 x 1795
Dimensions of perfo perforated panels W x D [mm]	621 x 480	621 x 480	848 x 480	848 x 480	1.298 x 480	1.298 x 480
perfo perforated panels	4	6	4	6	4	6
ESD	Yes	Yes	Yes	Yes	Yes	Yes
Order ref.	41014032.20	41014031.20	41014012.20	41014011.20	41014014.20	41014013.20

Mobile systems

Parts trolley



- For the provision of material and tools at the workstation
- Robust base frame with swivel castors, diameter 100 mm, 2 with brakes
- Available in 2 heights
- avero vertical profiles central in installation position, for assembly on both sides, positioning of the trolley at the side of the workstation
- Installation option for avero accessories in the system widths 675, 900 and 1350 mm
- Load capacity 200 kg
- Colour: anthracite grey (RAL 7016)

System width [mm]	675	675	900	900	1.200	1.350	1.350
Fits between 2 vertical profiles on system width [mm]	900	900	1350	1350	1,350	1800	1800
Dimensions W x D x H [mm]	675 x 675 x 1315	675 x 675 x 1795	900 x 675 x 1315	900 x 675 x 1795	1200 x 675 x 1795	1350 x 675 x 1315	1350 x 675 x 1795
Order ref.	41014030.19	41014029.19	41014024.19	41014023.19	41014037.19	41014026.19	41014025.19

Set of push handles for parts and supply trolley



- For installation on the avero vertical profile
- Made of conductive powder-coated sheet steel
- Colour: anthracite grey (RAL 7016)

Version	2 push handles
Order ref.	41011094.71

Mobile systems

Parts trolley ESD



- For the provision of material and tools at the workstation
- Robust base frame with swivel castors, diameter 100 mm, 2 with brakes
- Available in 2 heights
- avero vertical profiles central in installation position, for assembly on both sides, positioning of the trolley at the side of the workstation
- Installation option for avero accessories in the system widths 675, 900 and 1350 mm
- Load capacity 200 kg
- Made of conductive powder-coated sheet steel
- Colour: anthracite grey (RAL 7016)
- ESD version with conductive swivel castors

System width [mm]	675	675	900	900	1.200	1.350	1.350
Fits between 2 vertical profiles on system width [mm]	900	900	1350	1350	1,350	1800	1800
Dimensions W x D x H [mm]	675 x 675 x 1315	675 x 675 x 1795	900 x 675 x 1315	900 x 675 x 1795	1200 x 675 x 1795	1350 x 675 x 1315	1350 x 675 x 1795
Order ref.	41014030.71	41014029.71	41014024.71	41014023.71	41014037.71	41014026.71	41014025.71

Base shelf for parts and supply trolley



- For installation on the base frame of the parts and supply trolley
- Load capacity 100 kg
- Raised lip 25 mm all the way round
- Made of conductive powder-coated sheet steel
- Colour: anthracite grey (RAL 7016)

For system width [mm]	675	900	1.200	1.350
Dimensions W x D x H [mm]	675 x 660 x 25	900 x 660 x 25	1260 x 660 x 25	1350 x 660 x 25
Order ref.	42105048.71	42105031.71	42105054.71	42105037.71

Mobile systems

Trolley with constant level for standing work positions



- Load height: max. 840 mm (evenly distributed)
- Load capacity: max. 105 kg (evenly distributed)
- Robust base frame with swivel castors, diameter 100 mm, 2 with brakes
- Spring strength can be reduced by removing individual springs
- Automatic adjustment of the cargo area through spring packages after individual boxes have been removed
- Colour: light grey (RAL 7035)

Dimensions W x D x H [mm]	635 x 640 x 1875	435 x 790 x 1875
Cargo area W x D [mm]	600 x 400	400 x 600
Order ref.	11034018.16	11034021.16

Trolley with constant level for standing work positions ESD



- Load height: max. 840 mm (evenly distributed)
- Load capacity: max. 105 kg (evenly distributed)
- Robust base frame with swivel castors, diameter 100 mm, 2 with brakes
- Spring strength can be reduced by removing individual springs
- Automatic adjustment of the cargo area through spring packages after individual boxes have been removed
- Made of conductive powder-coated sheet steel
- Colour: light grey (RAL 7035)
- ESD version with conductive castors



Dimensions W x D x H [mm]	635 x 640 x 1875	435 x 790 x 1875
Cargo area W x D [mm]	600 x 400	400 x 600
Order ref.	11034019.20	11034021.20

Trolley with constant level for seated workplaces



- Load height: max. 600 mm (evenly distributed)
- Load capacity: max. 75 kg (evenly distributed)
- Robust base frame with swivel castors, diameter 100 mm, 2 with brakes
- Spring strength can be reduced by removing individual springs
- Automatic adjustment of the cargo area through spring packages after individual boxes have been removed
- Colour: light grey (RAL 7035)

Dimensions W x D x H [mm]	635 x 640 x 1200	435 x 790 x 1200
Cargo area W x D [mm]	600 x 400	400 x 600
Order ref.	11034005.16	11034020.16

Trolley with constant level for seated workplaces ESD



- Load height: max. 600 mm (evenly distributed)
- Load capacity: max. 75 kg (evenly distributed)
- Robust base frame with swivel castors, diameter 100 mm, 2 with brakes
- Spring strength can be reduced by removing individual springs
- Automatic adjustment of the cargo area through spring packages after individual boxes have been removed
- Made of conductive powder-coated sheet steel
- Colour: light grey (RAL 7035)
- ESD version with conductive castors

Dimensions W x D x H [mm]	635 x 640 x 1200	435 x 790 x 1200
Cargo area W x D [mm]	600 x 400	400 x 600
Order ref.	11034013.20	11034020.20

Mobile systems

Trolley



- For the provision of material and tools at the workstation
- Infinitely variable work height 770-1050 mm
- Locked by clamp lever
- Load capacity 60 kg
- Robust base frame with swivel castors, diameter 100 mm, 2 with brakes
- Colour: light grey (RAL 7035)
- Delivery does not include worktop

Version	Frame without panel
Dimensions W x D x H [mm]	560 x 640 x 1020
Weight [kg]	27.00
Order ref.	11034002.16

Trolley ESD



- For the provision of material and tools at the workstation
- Infinitely variable work height 770-1050 mm
- Locked by clamp lever
- Load capacity 60 kg
- Robust base frame with swivel castors, diameter 100 mm, 2 with brakes
- Made of conductive powder-coated sheet steel
- Colour: light grey (RAL 7035)
- Delivery does not include worktop
- ESD version with conductive swivel castors

Version	Frame without panel
Dimensions W x D x H [mm]	560 x 640 x 1020
Weight [kg]	30.00
Order ref.	11034010.20

Suitable worktops for the trolley

Version	Melamine-coated	Melamine-coated ESD	Laminate coated	Laminate coated ESD	Beech multiplex
Dimensions W x D x H [mm]	600 x 665 x 30	600 x 665 x 30	600 x 665 x 30	600 x 665 x 30	600 x 665 x 30
Weight [kg]	7.80	7.80	7.80	7.80	7.80
Order ref.	11201178.01	11201178.04	11201178.02	11201178.05	11201178.08

LEAN point mobile



- Compact work and information station
- For the simple and structured provision of information and tools
- Ideal for the workshop, shipping, QA and production
- Creates order and clarity in operation and allows work to be done according to lean management principles
- Depending on the version also equipped with power sockets and modern LED lights
- Can be flexibly adapted through comprehensive avero and perfo accessories

Dimensions W x D x H [mm]	1350 x 870 x 2330
For plug system	-
Version	Basic
Order ref.	41011207.16

Installation kits

Description	Universal installation kit M6 connection	Installation kit for shelf trays	Fixing kit for strip lights	Installation kit roller strips	Installation kit for return strips
Included	4x each cage nut/screw/washer				
Order ref.	90099561	90099564	90099582	90099571	41011159.71

Spare Parts

Version	avero drive control for LA31 drive (stroke 300 mm)	avero drive control for LA31 drive (stroke 400 mm)	Hydraulic actuator (stroke 300 mm)	Hydraulic actuator (stroke 400 mm)
Order ref.	85001149	85001100	85001074	85001073

Spare Parts

Version	Slat plug, PU 10	Operating element DP1U	For docking trolley	For docking trolley	For roller strips
Order ref.	90099875	85001101	90099788.19	90099791.19	90099792.19



If you have any questions about bott products or would like to place an order by telephone, the bott dialog-aktiv telesales team will be happy to assist:

+49 (0) 7971 / 251 – 251.

Or you can send your query by email to: **info@bott.de**



www.bott.com

Bott GmbH & Co. KG, Bahnstraße 17, 74405 Gaildorf, Germany

dialog-aktiv telesales team: Phone: +49 (0)79 71 / 251-251, Telefax: +49 (0)79 71 / 251-205

